



Metered Rack Power Distribution Unit

Installation Manual

**Instructions**

This symbol is intended to alert the user to the presence of important operating and maintenance (servicing) instructions in the literature accompanying the appliance.

**Dangerous Voltage**

This symbol is intended to alert the user to the presence of un-insulated dangerous voltage within the product's enclosure that may be of sufficient magnitude to constitute a risk of electric shock to persons.

**Protective Grounding Terminal**

This symbol indicates a terminal that must be connected to earth ground prior to making any other connections to the equipment.

Life-Support Policy

As a general policy, Server Technology® does not recommend the use of any of its products in the following situations:

- life-support applications where failure or malfunction of the Server Technology product can be reasonably expected to cause failure of the life-support device or to significantly affect its safety or effectiveness.
- direct patient care.

Server Technology will not knowingly sell its products for use in such applications unless it receives in writing assurances satisfactory to Server Technology that:

- the risks of injury or damage have been minimized,
- the customer assumes all such risks, and
- the liability of Server Technology is adequately protected under the circumstances.

The term life-support device includes but is not limited to neonatal oxygen analyzers, nerve stimulators (whether used for anesthesia, pain relief or other purposes), auto-transfusion devices, blood pumps, defibrillators, arrhythmia detectors and alarms, pacemakers, hemodialysis systems, peritoneal dialysis systems, neonatal ventilator incubators, ventilators (for adults or infants), anesthesia ventilators, infusion pumps, and any other devices designated as "critical" by the U.S. FDA.

Notices

301-0113-1 Rev J (052016)

Copyright © 2005-2016 Server Technology, Inc. All rights reserved.

1040 Sandhill Drive

Reno, Nevada 89521 USA

All Rights Reserved

This publication is protected by copyright and all rights are reserved. No part of it may be reproduced or transmitted by any means or in any form, without prior consent in writing from Server Technology.

The information in this document has been carefully checked and is believed to be accurate. However, changes are made periodically. These changes are incorporated in newer publication editions. Server Technology may improve and/or change products described in this publication at any time. Due to continuing system improvements, Server Technology is not responsible for inaccurate information which may appear in this manual. For the latest product updates, consult the Server Technology web site at www.servertech.com. In no event will Server Technology be liable for direct, indirect, special, exemplary, incidental, or consequential damages resulting from any defect or omission in this document, even if advised of the possibility of such damages.

In the interest of continued product development, Server Technology reserves the right to make improvements in this document and the products it describes at any time, without notices or obligation.

The Globe logo is a trademark of Server Technology, Inc., registered in the US. Use of the logos for commercial purposes without the prior written consent of Server Technology may constitute trademark infringement and unfair competition in violation of federal and state laws.

Server Technology, the Globe logo, Sentry, Switched CDU, CDU, PRO2, PIPS, POPS, PDU Power Pivot, and StartUp Stick are trademarks of Server Technology, Inc., registered in the US. EZip is a trademark of Server Technology.

Other trademarks and trade names may be used in this document to refer to either the entities claiming the marks and names or their products. Server Technology, Inc. disclaims any proprietary interest in trademarks and trade names other than its own.

**Please Recycle**

Shipping materials are recyclable. Please save them for later use, or dispose of them appropriately.

Table of Contents

CHAPTER 1: INTRODUCTION	4
Quick Installation Checklist.....	4
Technical Support.....	4
PDU Power Pivot®.....	5
Equipment Overview.....	6
CHAPTER 2: INSTALLATION	7
Standard Accessories.....	7
Additional Required Items.....	7
Safety Precautions.....	8
Input Power Cord Retention Options for Units with IEC C20 Inlets.....	9
Attaching Safety Earth Ground Connection.....	10
Mounting the PDU.....	11
Connecting to the Power Source.....	12
Connecting Devices.....	12
APPENDIX A: TECHNICAL SPECIFICATIONS	13
Branch Circuit Protection.....	13
Regulatory Compliance.....	16
APPENDIX B: PRODUCT SUPPORT INFORMATION	18
Warranty.....	18
Contact Technical Support.....	18
Return Merchandise Authorization.....	18

Chapter 1: Introduction

Quick Installation Checklist

The following steps are recommended to quickly install and configure the Metered Rack Power Distribution Unit (PDU) for use in your data center equipment cabinet:

1. Mount the PDU.
2. Connect to the power source.
3. Connect the devices.

Technical Support



Experience Server Technology's FREE Technical Support

Server Technology® understands that there are often questions when installing and/or using a new product. Free Technical Support is provided from 8 a.m. to 5 p.m. PST, Monday through Friday. After-hours service is provided to ensure your requests are handled quickly no matter what time zone or country you are located in.

Server Technology, Inc.

1040 Sandhill Drive

Tel: 1-800-835-1515

Web: www.servertech.com

Reno, Nevada 89521 USA

Fax: 775-284-2065

Email: support@servertech.com

PDU Power Pivot®

Server Technology's PDU Power Pivot® flexible infeed provides a simplified power cord routing to the unit with a design that eliminates bend radius issues.

As illustrated below, the PDU Power Pivot capability can deliver a solution for several types of PDU installations and mountings, setting the correct cord angle for overhead power, offset overhead power, concrete floor, raised floor, and intra-rack power.

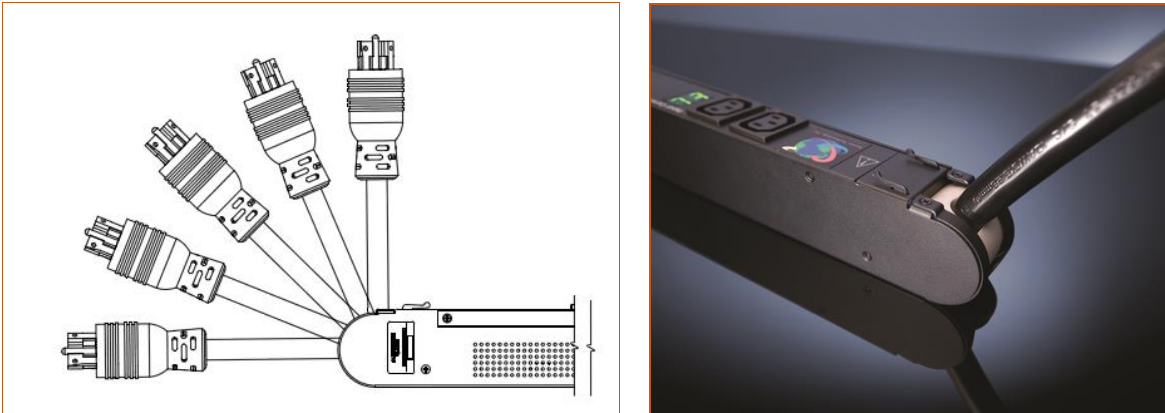

PDU Power Pivot – Flexible Cord Design

To learn more about PDU Power Pivot and watch a brief video that animates the PDU Power Pivot mounting angles in the equipment rack, see the Server Technology website at: <http://info.servertech.com/PDUpowerpivot>

Equipment Overview

1. The input current LED(s) displays the current load for each infeed or electrical phase per infeed.

NOTE: Metered products operate with an extra decimal point illuminating in the input current LED for about a half-second every four seconds. This slow flashing is typical of metered products and indicates normal operation of the processor inside the metered PDU.

2. The power inlet/cord(s) connects the PDU to the electrical power source.

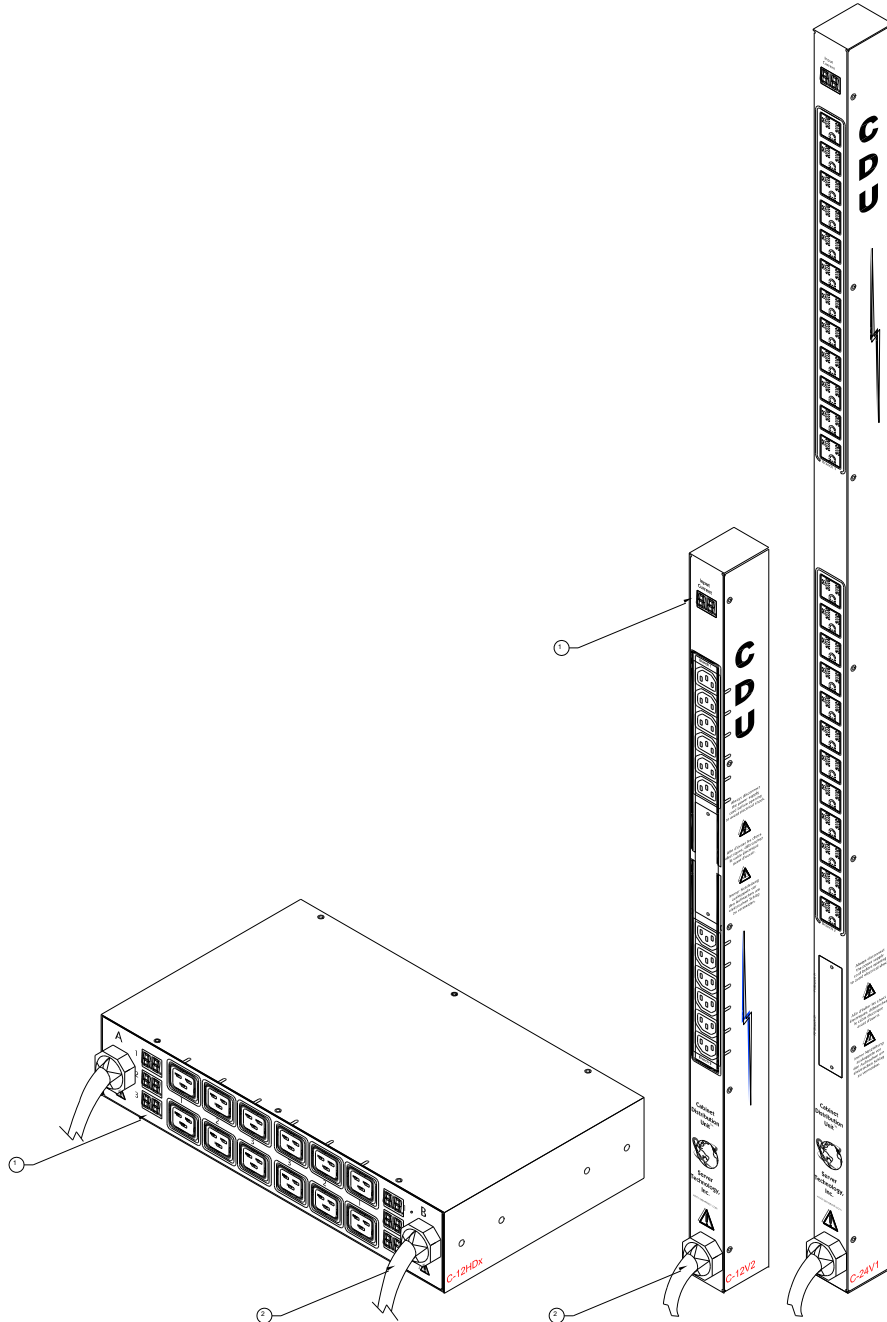

Views of the Metered Rack Power Distribution Unit (PDU)

Chapter 2: Installation

Before installing your Metered Rack Power Distribution Unit (PDU), refer to the following lists to ensure that you have all the items shipped with the unit as well as all other items required for proper installation.

Standard Accessories

Mounting Hardware

Vertical Models:

Two mounting buttons with two M4 (10 mm) screws.

Horizontal Models:

Two removable L-brackets with four M4 screws.

Expansion Models:

RJ12 to RJ12 crossover cable.

Additional Items for Models with C20 Inlets

- Separate power input cord required (typically sold as a separate line item)
- Optional power input retention bracket hardware (can be installed); two removable T-brackets with two 40 mm screws per input.













NOTE: This bracket is not compatible with Server Technology Input Power Cords with the self-locking C19 feature. These power cords have the prefix PTCORD-L#.

Additional Required Items

- Flathead and Phillip screwdrivers
- Screws, washers, and nuts to attach the PDU to your equipment rack.

Safety Precautions

This section contains important safety and regulatory information that **must be reviewed** before installing and using the Metered Rack Power Distribution Unit (PDU).

	Only for installation and use in a Restricted Access Location in accordance with the following installation and use instructions. This equipment should only be installed by trained personnel.	Destiné à l'installation et l'utilisation dans le cadre de Restricted Access Location selon les instructions d'installation et d'utilisation. Cet équipement est uniquement destiné à être installé par personnel qualifié.	Nur für Installation und Gebrauch in eingeschränkten Betriebszonen gemäß der folgenden Installations- und Gebrauchsanweisungen. Dieses Gerät ist nur für den Einbau durch Personal vorgesehen.
	This equipment is designed to be installed on a dedicated circuit. The power supply cord shall be a minimum of 1.5m (4.9ft) and a maximum of 4.5m (15ft). If using an extension power cord, the total length shall also be no more than the maximum allowed. The plug is considered the disconnect device and must be easily accessible.	Cet équipement a été conçu pour être installé que un circuit dédié. Le cordon d'alimentation doit être d'au moins 1,5M et un maximum de 4,5m. Si vous utilisez un cordon de rallonge, la longueur totale est également plus que le maximum autorisé. La prise est considérée comme un dispositif de coupure et doit être facilement accessible.	Die Geräte sind für eine Installation an einer fest zugeordneten Leitung ausgelegt. Die Stromzuleitung hat eine Mindestlänge von 1,5m, und höchstens 4,5m. Sollten Sie ein Verlängerungskabel, der Gesamtlänge auch nicht mehr als die maximal zulässige sein. Der Stecker dient zur Trennung vom Netz und muss einfach erreichbar sein.
	The dedicated circuit must have circuit breaker or fuse protection. PDUs have been designed without a master circuit breaker or fuse to avoid becoming a single point of failure. It is the customer's responsibility to provide adequate protection for the dedicated power circuit. Protection of capacity equal to the current rating of the PDU must be provided and must meet all applicable codes and regulations. In North America, protection must have a 10,000A interrupt capacity.	Le circuit spécialisé doit avoir un disjoncteur ou une protection de fusible. PDUs ont été conçus sans disjoncteur général ni fusible pour éviter que cela devient un seul endroit de panne. C'est la responsabilité du client de fournir une protection adéquate pour le circuit-alimentation spécialisé. Protection de capacité équivalant à la puissance de l'équipement, et respectant tous les codes et normes applicables. Les disjoncteurs ou fusibles destinés à l'installation en Amérique du Nord doivent avoir une capacité d'interruption de 10.000 A.	Der feste Stromkreis muss mit einem Schutzscharter oder einem Sicherungsschutz versehen sein. PDUs verfügt über keinen Hauptschutzschalter bzw. über keine Sicherung, damit kein einzelner Fehlerpunkt entstehen kann. Der Kunde ist dafür verantwortlich, den Stromkreis sachgemäß zu schützen. Der Kapazitätsschutz entspricht der aktuellen Stromstärke der Geräte und muss alle relevanten Codes und Bestimmungen erfüllen. Für Installation in Nordamerika müssen Ausschalter bzw. Sicherung über 10.000 A Unterbrechungskapazität verfügen.
	Models with unterminated power cords: Input connector must be installed by qualified service personnel. Input connector rating must meet all applicable codes and regulations.	Modèles avec cordons d'alimentation non terminées: Le connecteur d'entrée doit être installé par un personnel qualifié. Entrée cote de raccordement doit respecter tous les codes et règlements électriques applicables.	Modelle mit nicht abgeschlossenen Netzkabel: Der Eingangsstecker darf nur von qualifiziertem Wartungspersonal installiert werden. Eingangsanschluss Bewertung müssen alle geltenden und verbindlichen Normen und Vorschriften entsprechen.
	Do not block venting holes when installing this product. Allow for maximum airflow at all times.	Ne bloquez pas les orifices d'aération lors de l'installation de ce produit. Permettre une circulation d'air maximale à tout moment.	Achten Sie darauf, dass keine Belüftungslöcher bei der Installation dieses Produkts. Damit für maximalen Luftstrom zu allen Zeiten.
	Installation Orientation: Vertical units are designed to be installed in vertical orientation.	Installation Orientation: Les unités vertical sont conçues pour être installées dans une orientation verticale.	Installationsausrichtung: Vertical Einheiten sind zur vertikalen Installation vorgesehen.
 	Always disconnect the power supply cord before servicing to avoid electrical shock. For products with two input power cords, both must be disconnected before servicing.	Toujours débrancher le cordon d'alimentation avant de l'ouverture pour éviter un choc électrique. Pour les produits avec deux cordons d'alimentation d'entrée, les deux doivent être déconnectés avant l'entretien.	Trennen Sie das Netzkabel, bevor Sie Wartungsarbeiten Öffnung einen elektrischen Schlag zu vermeiden. Für Produkte mit zwei Eingangsstromkabel, sowohl, müssen vor der Wartung abgeschaltet werden.
	WARNING! High leakage current! Earth connection is essential before connecting supply!	ATTENTION! Haut fuite très possible! Une connection de masse est essentielle avant de connecter l'alimentation !	ACHTUNG! Hoher Ableitstrom! Ein Erdungsanschluss ist vor dem Einschalten der Stromzufuhr erforderlich!
 	WARNING! Cx-xxE-x units double pole/neutral fusing	ATTENTION! Les unités Cx-xxE-x Double Pôle/Fusible sur le Neutre	ACHTUNG! Cx-xxE-x Zweipolige bzw. Neutralleiter-Sicherung
	ATTENTION! Observe precautions for handling Electrostatic Sensitive Devices.	Attention ! Respecter les mesures de sécurité en manipulant des dispositifs sensibles aux décharges électrostatiques.	Achtung! Vorsichtshinweise zur Handhabung elektrostatisch empfindlicher Geräte beachten.
	Products rated for 240/415VAC may be fitted with a plug that is rated for a higher voltage. Caution must be taken to assure that the rating of the unit and the supply voltage match.	Les produits prévus pour 240/415VAC peut être équipé d'un bouchon qui est conçu pour une tension plus élevée. Des précautions doivent être prises pour assurer que la cote de l'unité et la tension d'alimentation correspond.	Produkte die für 240/415VAC zugelassen sind können mit einem Stecker der für eine höhere Spannung ausgestattet sein. Vorsicht ist geboten, um sicherzustellen, dass die erlaubten Betriebswerte des Gerätes und der Versorgungsspannung zueinander passen.

Input Power Cord Retention Options for Units with IEC C20 Inlets

Determine which Detachable Input Cord was supplied with the PDU:

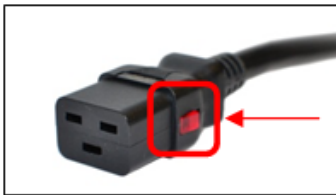

For the following Detachable Input Cords with the self-locking IEC C19 feature, follow Procedure A below.

PTCORD-L1, PTCORD-L2, PTCORD-L3, PTCORD-L5, PTCORD-L6, or PTCORD-L7.



For the following Detachable Input Cords, follow Procedure B below.

PTCORD-1, PTCORD-2, PTCORD-3, PTCORD-4, PTCORD-5, PTCORD-6, or PTCORD-7.

Procedure A

If the PDU was supplied with a Detachable Input Power Cord with a self-locking IEC C19, install it directly into the C20 inlet.

1. Verify the Retention Bracket Assembly (part number KIT-0016) is not installed.
 - a. If KIT-0016 is installed, remove the two screws attaching the bracket to the IEC 60320 C20 inlet to the enclosure.
 - b. Remove the Retention Bracket Assembly.
 - c. Re-attach the two screws to the IEC C20 and securely tighten.
2. Push the C19 from the Detachable Input Cord firmly into the C20 inlet to ensure it is properly seated.

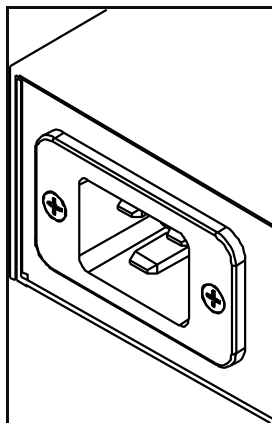

C20 Inlet Without Retention Bracket Assembly

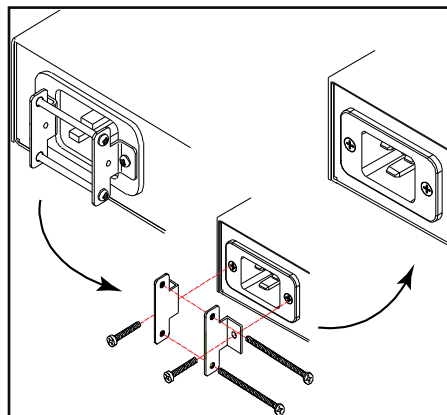

KIT-0016 Retention Bracket Assembly

Procedure B

If the PDU was supplied with a Detachable Input Power Cord without the self-locking C19 feature, install with the Retention Bracket Assembly (part number KIT-0016), followed by the power cord.

1. Remove the two screws attaching the IEC 60320 C20 inlet to the enclosure.
2. Assemble and attach the Retention Bracket to the enclosure as shown
3. Connect the power cord. Ensure the C19 is fully seated against the C20 inlet. (It may be necessary to loosen some of the Retention Bracket Assembly screws to allow the C19 plug to be properly installed.)
4. Tighten the Retention Bracket Assembly to restrain the power cord.

Attaching Safety Earth Ground Connection

Server Technology PDUs are supplied with an external safety ground connection to provide an alternate ground path for fault currents, and to maintain the same ground reference between it and the equipment rack.

NOTE: The auxiliary external ground location may vary. Most PDUs will have it located near the power cord entry located near the  symbol.

User-supplied materials:

- One 5 mm internal (or external) tooth star washer;
- One 4.0 mm² (10 AWG) wire with 5 mm ring terminal;
- One metric M5 x 6 mm coarse pitch screw.

Instructions:

1. Connect one end of the ground wire to the equipment cabinet or local ground.
2. Locate the PDU external ground near the  symbol.
3. Connect the other end with a ring terminal and a M5 screw to the PDU external ground. To ensure proper grounding to the chassis, use a star washer between the ring terminal and the PDU.

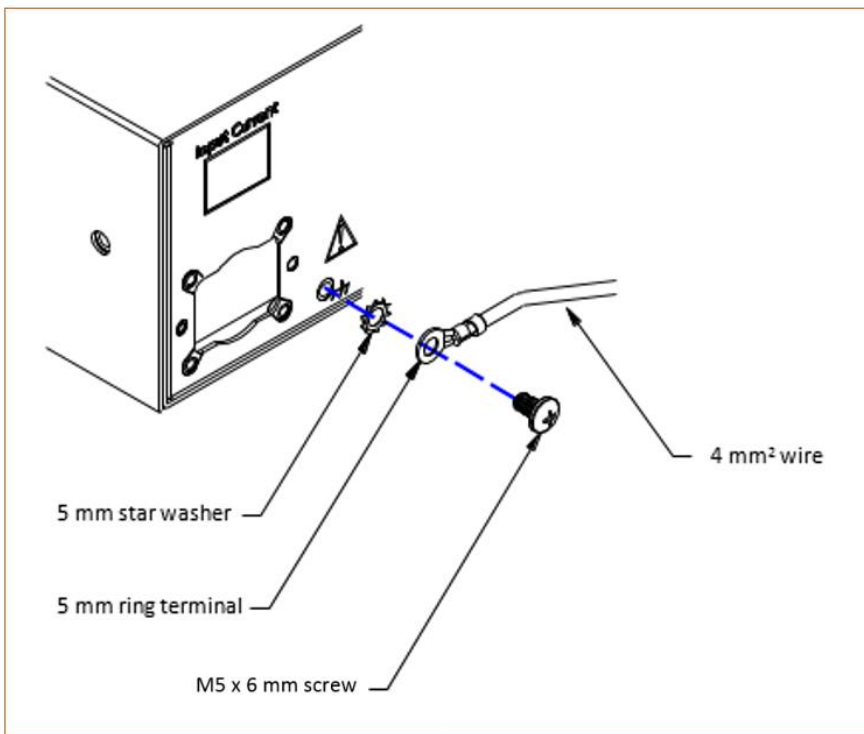

Mounting the PDU

The following illustration shows how to mount the Metered PDU in vertical or horizontal orientation:

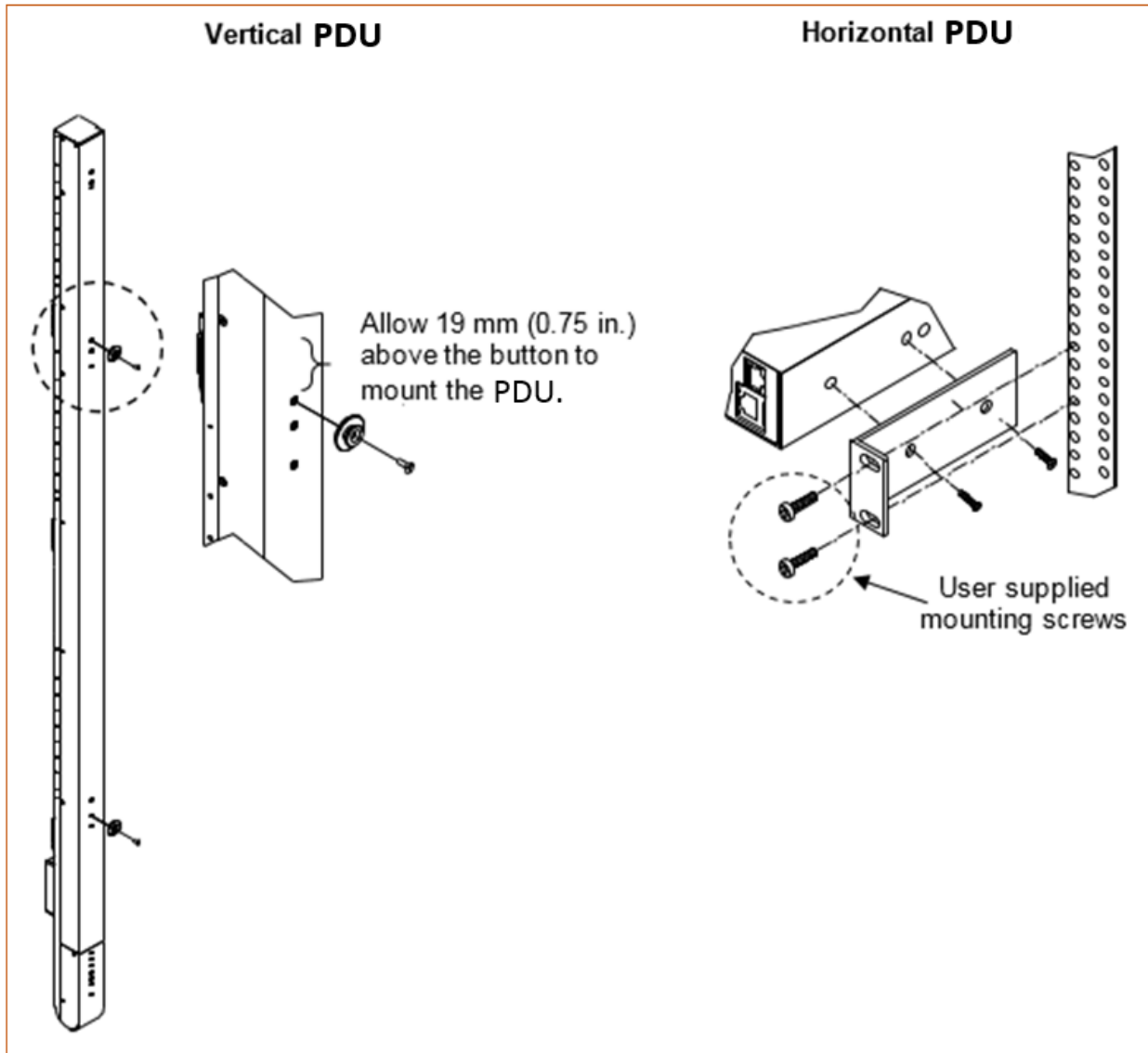

Horizontal/Rack

1. Select the appropriate bracket mounting points for proper mounting depth within the rack.
2. Attach the L-brackets to these mounting points with two screws for each bracket.
3. Install the enclosure into your rack, using the slots in each bracket. The slots allow about 6 mm (0.25 inch) of horizontal adaptability to align with the mounting holes of your rack.

Vertical

The Switched PDU is supplied with button mounting kit(s). Distribute the buttons vertically and attach to the PDU as appropriate for the cabinet. An additional 19 mm (0.75 inch) of clearance is required at the top of the PDU to allow the button to mount into the keyholes.

NOTE: For more information about horizontal/vertical mounting options for the Switched PDU, see the [Server Technology PDU Mounting Bracket Catalog](#):

http://cdn1.servertech.com/assets/documents/documents/1803/original/Mounting_Bracket_Catalog.2014-12-30.pdf?1420823515

Connecting to the Power Source

On 30A units, the input power cord is attached to the base of the unit. On units with a total maximum output <30A, you must first attach the power cord to the unit before connecting the unit to the power source.

To attach a power cord to the unit:

1. Plug the female end of the power cord firmly into its connector at the base.
2. Use a screwdriver to tighten the two screws on the retention bracket.

To connect to the power source:

Plug the male end of the power cord into the AC power source.

Connecting Devices

1. Keep the device's on/off switch in the off position until after it is plugged into the outlet.
2. Connect devices to the CDU outlets.

NOTE: Server Technology recommends even distribution of attached devices across all available outlets to avoid exceeding the outlet, branch or phase limitations.



Always disconnect ALL power supply cords before opening to avoid electrical shock.
Afin d'éviter les chocs électriques, débranchez TOUTES les cables électrique avant d'ouvrir.
Vor dem Öffnen immer Netzleitungen abziehen um elektrischen Schlag zu vermeiden.

Appendix A: Technical Specifications

Branch Circuit Protection

Server Technology PDUs are equipped with one of several types of Branch Circuit Protection, including internal fuses, retractable fuse holders, and circuit breakers, as illustrated below.

These fuses and circuit breakers meet the strict safety requirements of UL 60950-1 and EN 60950-1 for Branch Circuit Protection.



Circuit Breaker



Compact Fuse Holder

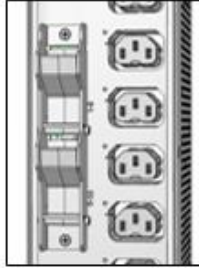

Fuse Retractor



Fuse Access Window

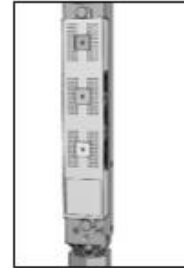

Fuse Access Cover

Circuit Breaker

If a circuit breaker is tripped, it can be reset by pressing or switching it back ON once the cause of the overload or short circuit has been identified, removed, or resolved. Intelligent PDUs with branch circuit sensing will display a flashing *FE* on the input current LED(s) to indicate *Fuse Error*.



Alternatively, the circuit breaker can be turned OFF manually by inserting a slotted or flat-blade tool into the OFF switch as shown in the illustration on the left.

It is not necessary to disconnect the AC power source to perform this operation.

NOTE: This circuit breaker contains no user-serviceable parts. Do not open or disassemble this part.

Compact Fuse Holder

The Compact Fuse Holder is a UL 98 listed Fused Disconnect Switch that allows the user to turn OFF the branch circuit and safely service the fuse without having to disconnect the PDU AC power source prior to performing this operation.

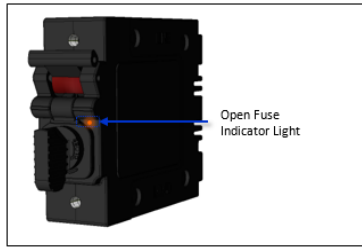

To help identify which fuse is open, blown, or missing, the Open Fuse Indicator Light glows **orange** when the PDU is powered and the Switch Handle is in the ON position.

Additionally, intelligent PDUs with branch circuit sensing will display a flashing *FE* on the input current LEDs to indicate *Fuse Error*.

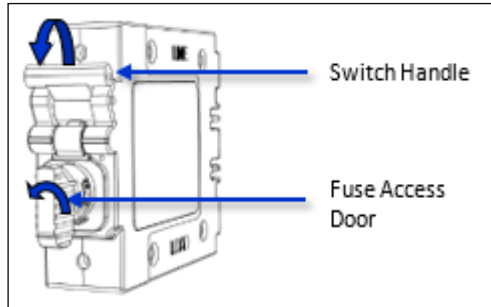

To service the fuse or turn OFF the branch, rotate the Switch Handle toward the Fuse Access Door.

Next, rotate the Fuse Access Door counter clock-wise until it opens.

Only replace the fuse with the same size, type, and ratings as the original fuse.

Reverse these steps after the new fuse(s) is installed.

CAUTION:

- Failure to replace the fuse with the same size, type, and ratings will damage the PDU and the connected and nearby equipment, and will cause electrical shock, fire, explosion, or injury/death.
 - Do not attempt to open the Fuse Access Door without first setting the Switch Handle in the OFF position. Forcibly rotating the Fuse Access Door will damage the fused holder.
-

Fuse Retractor, Fuse Access Window, and Fuse Access Cover



The PDU AC power source must be disconnected prior to servicing a unit with the Fuse Retractor, Fuse Access Window, and Fuse Access Cover.

Intelligent PDUs with branch circuit sensing will display a flashing *FE* on the input current LEDs to indicate *Fault Error*.

For the fuse retractor, rotate the fuse holder exposing the fuse.

For the fuse access window or cover, remove the screws that secure the plastic cover.

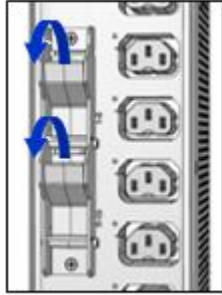

Fuse Retractor



Fuse Access Window



Fuse Access Cover

Once the fuses are exposed, carefully remove and replace with a new one of the same size, type, and ratings as the original. A fuse puller may be needed for fuse access windows and covers.

Reverse these steps after the new fuse(s) is installed.

CAUTION:

Failure to replace the fuse with the same size, type, and ratings will damage the PDU and the connected and nearby equipment, and will cause electrical shock, fire, explosion, or injury/death.

Time-Delay Fuses – Class G

NOTE: Server Technology PDUs ship with Bussman SC-20 fuses.

Ampere Rating	Voltage	Interrupting Rating	Bussman Part No.*	Server Technology Part No.
20 A	600 Vac	100,000 A RMS Sym. AC	SC-20	FUSE-SC20G

* Cooper Bussman Technical Data Sheet 1024

For technical support or service with time-delay fuses, contact Server Technology as follows:



Experience Server Technology's FREE Technical Support

Server Technology understands that there are often questions when installing and/or using a new product. Free Technical Support is provided from 8 a.m. to 5 p.m. PST, Monday through Friday. After-hours service is provided to ensure your requests are handled quickly no matter what time zone or country you are located in.

Server Technology, Inc.

1040 Sandhill Drive

Tel: 1-800-835-1515

Web: www.servertech.com

Reno, Nevada 89521 USA

Fax: 775-284-2065

Email: support@servertech.com

Regulatory Compliance

Product Safety

Units have been safety tested and certified to the following standards:

- USA/Canada UL 60950:2003 and CAN/CSA 22.2 No. 60950-1-03
- European Union EN60950-1:2001

This product is also designed for Norwegian IT power system with phase-to phase voltage 230V.

USA Notification

Note: This equipment has been tested and found to comply with the limits for a Class A digital device, pursuant to part 15 of the FCC Rules. These limits are designed to provide reasonable protection against harmful interference when the equipment is operated in a commercial environment. This equipment generates, uses, and can radiate radio frequency energy and, if not installed and used in accordance with the instruction manual, may cause harmful interference to radio communications. Operation of this equipment in a residential area is likely to cause harmful interference in which case the user will be required to correct the interference at the user's own expense.

Modifications not expressly approved by the manufacturer could void the user's authority to operated the equipment under FCC rules.

Canadian Notification

This Class A digital apparatus complies meets all requirements of the Canadian Interference-Causing Equipment Regulations.

Cet appareil numérique de la classe A respecte toutes les exigences du Règlement sur le matériel brouilleur du Canada.

European Union Notification

Products with the CE Marking comply with both the EMC Directive (89/336/EEC) and the Low Voltage Directive (73/23/EEC) issued by the Commission of the European Community.

Compliance with these directives implies conformity to the following European Norms:

- EN55022 Electromagnetic Interference
- EN55024 Electromagnetic Immunity
- EN60950-1 Product Safety



- EN61000-3 Harmonics and Flicker

Products with the following mark comply with the RoHS Directive (2002/95/EC) issued by the Commission of the European Community.

Japanese Notification

この装置は、情報処理装置等電波障害自主規制協議会（VCCI）の基準に基づくクラスA情報技術装置です。この装置を家庭環境で使用すると電波妨害を引き起こすことがあります。この場合には使用者が適切な対策を講ずるよう要求されることがあります。

本製品に同梱または付属しております電源コードは、本製品専用です。本製品以外の製品ならびに他の用途に使用しないで下さい。

Chinese Notification

关于符合中国《电子信息产品污染控制管理办法》的声明

产品中有毒有害物质的名称及含量

部件名称 (Parts)	有毒有害物质或元素 (Hazardous Substance)					
	铅 (Pb)	汞 (Hg)	镉 (Cd)	六价铬 (Cr (VI))	多溴联苯 (PBB)	多溴二苯醚 (PBDE)
机箱子组件 (Chassis Subassembly)	O	O	O	O	O	O
印刷板组件 (PCAs)	X	O	O	O	O	O
<p>O 表示该有毒有害物质在该部件所有均质材料中的含量均在SJ/T 11363-2006 标准规定的限量要求以下。 Indicates that this hazardous substance contained in all homogeneous materials of this part is below the limit requirement in SJ/T 11363-2006.</p> <p>X 表示该有毒有害物质至少在该部件的某一均质材料中的含量超出SJ/T 11363-2006 标准 规定的限量要求。 Indicates that this hazardous substance contained in at least one of the homogeneous materials of this part is above the limit requirement in SJ/T 11363-2006.</p>						

Recycling



Server Technology Inc. encourages the recycling of its products. Disposal facilities, environmental conditions and regulations vary across local, state and country jurisdictions, so Server Technology encourages consultation with qualified professional and applicable regulations and authorities within your region to ensure proper disposal.

Waste Electrical and Electronic Equipment (WEEE)



In the European Union, this label indicates that this product should not be disposed of with household waste. It should be deposited at an appropriate facility to enable recovery and recycling.

Appendix B: Product Support Information

Warranty

For Server Technology warranty information, visit our website: www.servertech.com

Contact Technical Support



Experience Server Technology's FREE Technical Support

Server Technology understands that there are often questions when installing and/or using a new product. Free Technical Support is provided from 8 a.m. to 5 p.m. PST, Monday through Friday. After-hours service is provided to ensure your requests are handled quickly no matter what time zone or country you are located in.

Server Technology, Inc.

1040 Sandhill Drive

Tel: 1-800-835-1515

Web: www.servertech.com

Reno, Nevada 89521 USA

Fax: 775-284-2065

Email: support@servertech.com

Return Merchandise Authorization

If you have a product that is not functioning properly and needs technical assistance or repair, see the Server Technology **Return Merchandise Authorization** process at: www.servertech.com





Server Technology®

HEADQUARTERS -
NORTH AMERICA
Server Technology, Inc.
1040 Sandhill Road
Reno, NV 89521
United States
1.775.284.2000 Tel
1.775.284.2065 Fax
sales@servertech.com
www.servertech.com
www.servertechblog.com

Western Europe, Middle East and
Africa
Server Technology
Fountain Court
2 Victoria Square
Victoria Street
St. Albans
AL1 3TF
United Kingdom
+44 (0) 1727 884676 Tel
+44 (0) 1727 220815 Fax
salesint@servertech.com

Central Europe, Eastern Europe and
Russia
Niederlassung Deutschland
Server Technology LLC
42119 Wuppertal
Germany
Tel: + 49 202 693917 x 0
Fax: + 49 202 693917-10
salesint@servertech.com

APAC
Server Technology
Room 2301, 23/F, Future Plaza
111-113 How Ming Street,
Kwun Tong, Hong Kong
Direct line: +852 3916 2048
Fax Line: +852 3916 2002
salesint@servertech.com