



# PT45 Commander

## Installation and Operations Manual



### Instructions

This symbol is intended to alert the user to the presence of important operating and maintenance (servicing) instructions in the literature accompanying the appliance.



### Dangerous Voltage

This symbol is intended to alert the user to the presence of un-insulated dangerous voltage within the product's enclosure that may be of sufficient magnitude to constitute a risk of electric shock to persons.



### Protective Grounding Terminal

This symbol indicates a terminal that must be connected to earth ground prior to making any other connections to the equipment.

### Life-Support Policy

As a general policy, Server Technology® does not recommend the use of any of its products in the following situations:

- life-support applications where failure or malfunction of the Server Technology product can be reasonably expected to cause failure of the life-support device or to significantly affect its safety or effectiveness.
- direct patient care.

Server Technology will not knowingly sell its products for use in such applications unless it receives in writing assurances satisfactory to Server Technology that:

- the risks of injury or damage have been minimized,
- the customer assumes all such risks, and
- the liability of Server Technology is adequately protected under the circumstances.

The term life-support device includes but is not limited to neonatal oxygen analyzers, nerve stimulators (whether used for anesthesia, pain relief or other purposes), auto-transfusion devices, blood pumps, defibrillators, arrhythmia detectors and alarms, pacemakers, hemodialysis systems, peritoneal dialysis systems, neonatal ventilator incubators, ventilators (for adults or infants), anesthesia ventilators, infusion pumps, and any other devices designated as "critical" by the U.S. FDA.

### Notices

301-0113-1 Rev L (052016)

Copyright © 2005-2016 Server Technology, Inc. All rights reserved.

1040 Sandhill Drive

Reno, Nevada 89521 USA

### All Rights Reserved

This publication is protected by copyright and all rights are reserved. No part of it may be reproduced or transmitted by any means or in any form, without prior consent in writing from Server Technology.

The information in this document has been carefully checked and is believed to be accurate. However, changes are made periodically. These changes are incorporated in newer publication editions. Server Technology may improve and/or change products described in this publication at any time. Due to continuing system improvements, Server Technology is not responsible for inaccurate information which may appear in this manual. For the latest product updates, consult the Server Technology web site at [www.servertech.com](http://www.servertech.com). In no event will Server Technology be liable for direct, indirect, special, exemplary, incidental, or consequential damages resulting from any defect or omission in this document, even if advised of the possibility of such damages.

In the interest of continued product development, Server Technology reserves the right to make improvements in this document and the products it describes at any time, without notices or obligation.

The Globe logo is a trademark of Server Technology, Inc., registered in the US. Use of the logos for commercial purposes without the prior written consent of Server Technology may constitute trademark infringement and unfair competition in violation of federal and state laws.

Server Technology, the Globe logo, Sentry, Switched CDU, CDU, PRO2, PIPS, POPS, PDU Power Pivot, and StartUp Stick are trademarks of Server Technology, Inc., registered in the US. EZip is a trademark of Server Technology.

Other trademarks and trade names may be used in this document to refer to either the entities claiming the marks and names or their products. Server Technology, Inc. disclaims any proprietary interest in trademarks and trade names other than its own.



### Please Recycle

Shipping materials are recyclable. Please save them for later use, or dispose of them appropriately.

# Table of Contents

<b>CHAPTER 1: INTRODUCTION</b>	<b>4</b>
Quick Installation Checklist.....	4
Technical Support.....	4
PDU Power Pivot®.....	5
Equipment Overview.....	6
IPv6 and Server Technology Products.....	7
<b>CHAPTER 2: INSTALLATION</b>	<b>10</b>
Standard Accessories.....	10
Additional Required Items.....	10
Safety Precautions.....	11
Installing the Power Input Retention Bracket.....	12
Attaching Safety Earth Ground Connection.....	13
Mounting the PDU.....	14
Connecting to the Power Source.....	14
Connecting Devices.....	14
Connecting the Sensors.....	14
Connecting to the Unit.....	14
<b>CHAPTER 3: OPERATIONS</b>	<b>17</b>
Interfaces.....	19
Web Interface.....	20
Command Line Interface.....	47
<b>CHAPTER 4: ADVANCED OPERATIONS</b>	<b>88</b>
SSL.....	89
SSH.....	91
SNMP/Thresholds.....	93
LDAP.....	107
TACACS+.....	117
RADIUS.....	123
Logging.....	127
Upload/Download.....	131
Remote Shutdown.....	133
<b>CHAPTER 5: APPENDICES</b>	<b>137</b>
Appendix A: Resetting to Factory Defaults.....	137
Appendix B: Uploading Firmware.....	138
Appendix C: Technical Specifications.....	139
Appendix D: Product Support Information.....	146

# Chapter 1: Introduction

## Quick Installation Checklist

The following steps are recommended to quickly install and configure the PDU for use in your data center equipment cabinet:

1. Mount the PT45 Commander.
2. Connect to the power source.
3. Connect the devices.
4. Connect to the PT45.
5. Configure the PT45.
  - Login as the predefined administrator account (admin/admin).
  - Configure the network settings.
  - Create new administrative user account.
  - Configure location and PT45 names.
  - Configure new user account(s).
  - Remove the predefined administrator account.
6. Connect the PT45 to the network.

## Technical Support



### Experience Server Technology's FREE Technical Support

Server Technology® understands that there are often questions when installing and/or using a new product. Free Technical Support is provided from 8 a.m. to 5 p.m. PST, Monday through Friday.

After-hours service is provided to ensure your requests are handled quickly no matter what time zone or country you are located in.

Server Technology, Inc.

1040 Sandhill Drive

Tel: 1-800-835-1515

Web: [www.servertech.com](http://www.servertech.com)

Reno, Nevada 89521 USA

Fax: 775-284-2065

Email: [support@servertech.com](mailto:support@servertech.com)

## PDU Power Pivot®

Server Technology's PDU Power Pivot® flexible infeed provides a simplified power cord routing to the PDU with a design that eliminates bend radius issues.

As illustrated below, the PDU Power Pivot capability can deliver a solution for several types of PDU installations and mountings, setting the correct cord angle for overhead power, offset overhead power, concrete floor, raised floor, and intra-rack power.

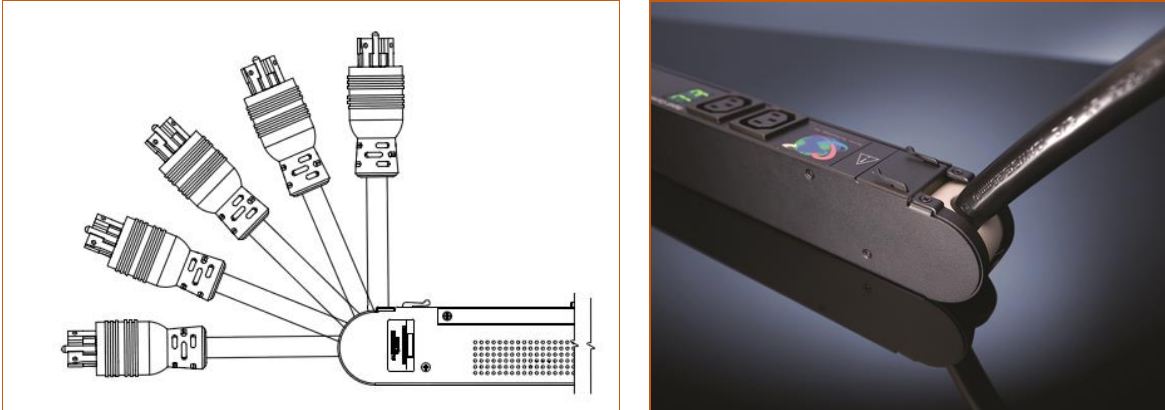

**PDU Power Pivot – Flexible Cord Design**

To learn more about PDU Power Pivot and watch a brief video that animates the PDU Power Pivot mounting angles in the equipment rack, see the Server Technology website at: <http://info.servertech.com/PDUpowerpivot>

## Equipment Overview

1. The power inlet/cord(s) connects the Commander to the electrical power source.
2. Black RJ12 Intelligent Power Module ports.
3. Grey RJ12 Pass-Thru console communication ports.
4. One DB9 Modem connector for connection to an external modem.
5. One RJ12 AUX connector for connection to an optional Environmental Monitor.
6. Two RJ45 connectors for Serial (RS-232) and Ethernet connection.
7. Two mini RJ11 connectors for temperature/humidity sensors.

A number is printed above each outlet. These numbers can be used in commands that require an outlet name. For more information, see the “Outlet Naming and Grouping” section in Chapter 3: Operations.

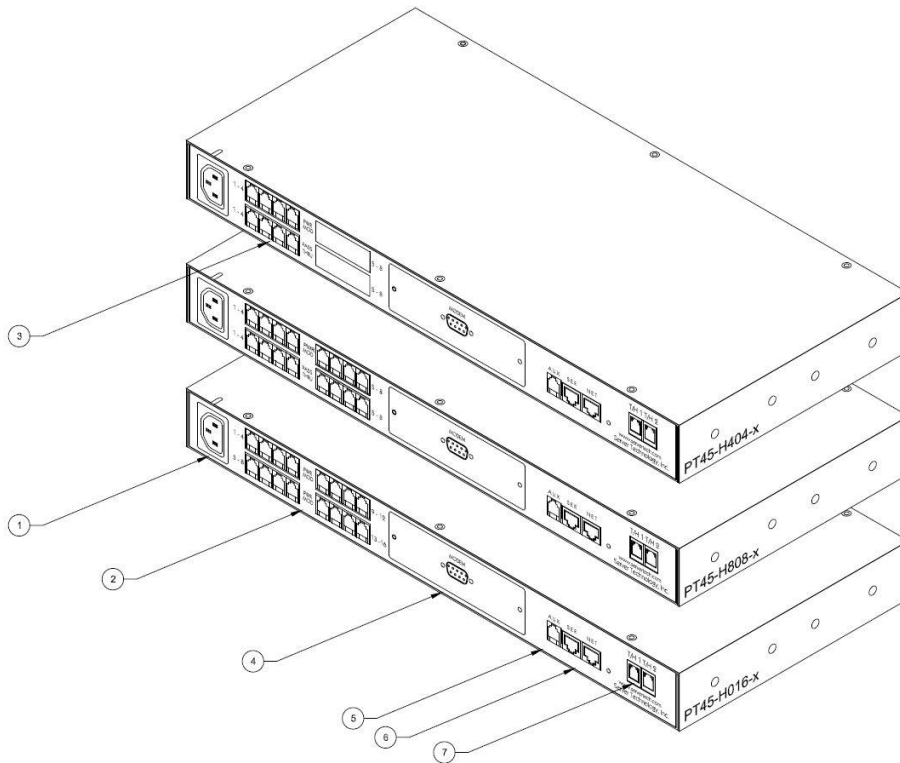

**PT45 Commander View**

## IPv6 and Server Technology Products

Server Technology is introducing IPv6 “dual stack” support to the PT45. IPv6 has been designed to succeed IPv4 as the dominant communications protocol for internet traffic, to avoid depletions of the IPv4 address space, and to allow more IP address growth. Many devices already in use support IPv6.

IPv6 has several new operational methods:

- Static IPv6 Address: The IPv6 equivalent of Static IPv4.
- DHCPv6 Address: The IPv6 equivalent of a DHCP IPv4 address, also known as a “stateful” auto-configuration of DHCPv6.
- IPv6 Stateless Auto-Configured Address – (RFC 4862): An automatically-generated unique link-local IPv6 address used for client based configurations. This address is always present in the Server Technology dual stack and cannot be disabled.
- DHCPv6 Stateless Auto-Configured Address – (RFC 3736): A “stateless” Dynamic Host Configuration Protocol (DHCP) service for IPv6 (DHCPv6). This address is used by nodes to obtain configuration information, such as addresses of DNS recursive name servers that do not require the maintenance of any dynamic state for individual clients.

### **PT45 Firmware – Protocol Support**

#### **IPv6 and IPv4 Protocols:**

The PT45 firmware supports the following network IPv6 and IPv4 protocols:

- DNS Ping
- FTP (or SFTP) Server SNMPv1/2/3
- FTP (or SFTP) Updates SNTP
- HTTP HTTPS
- SMTP
- Static IPv6 DHCPv6 (stateless and stateful)
- Syslog SNMPv1/2/3 Traps
- Telnet SSH

#### **IPv4-Only Protocols:**

The PT45 firmware supports the following network IPv4-only protocols:

- Cisco EnergyWise
- LDAP
- Load Shedding \*
- RADIUS \*
- TACACS+

\* = may work with IPv6 addresses, but not tested.

## Network-Enabled Modes

---

### NOTES:

- For all network-enabled modes described below, the PT45 will set an auto-configured IPv6 address, and if IPv6 router announcements are active, a stateless DHCP IPv6 address will also be set. Further, in all network-enabled modes, at least one IPv4 or one IPv6 address will be active.
  - For maximum backward compatibility, the default network mode is “IPv4 only”.
- 

- Network disabled – No IPv4 or IPv6 addresses available.
- IPv4 only, DHCP disabled (static IPv4) – If the IPv4 Static Address and Net Mask of the PT45 are valid, they will be set.
- IPv4 only, DHCP enabled (DHCP IPv4) – The PT45 will try to resolve an IPv4 DHCP address. If a DHCP address cannot be obtained after 90 seconds, the PT45 can: (1) optionally fall back to its static IPv4 settings, or (2) indefinitely wait to acquire an address based on DHCP configuration settings. **This setting is the default.**
- Dual IPv6/IPv4, DHCP disabled (static IPv6/IPv4) – If the IPv6 Static Address and prefix of the PT45 are valid, they will be set. Otherwise, the PT45 will attempt to use DHCPv6 to obtain an IPv6 address.

In addition, if the IPv4 Static Address and Net Mask of the PT45 are valid, they will be set.

- Dual IPv6/IPv4, DHCP enabled (DHCP IPv6/IPv4) – The PT45 will try to resolve both its IPv6 and IPv4 addresses by DHCP. If both DHCP requests are answered, the primary DNS server of the PT45 will become the primary IPv6 DNS server, and the secondary DNS server of the PT45 will become the primary IPv4 DNS server.

If only one of the DHCP requests is answered, the DNS servers of the PT45 will map to the primary and secondary DNS server from that request.

If a DHCP address cannot be obtained after 90 seconds, the PT45 can: (1) optionally fall back to its static IPv4 and/or IPv6 settings, or (2) indefinitely wait to acquire an address based on DHCP configuration settings.



## Viewing Network Status

You can obtain the IPv6 network status through the firmware Web Interface or Command Line Interface (CLI). For the CLI, use the **show network** command as follows:

```
Switched CDU: show network
Network Settings
  State: DHCP IPv6/IPv4 Network: Dual IPv6/IPv4
  Link: Up Negotiation: Auto
  Speed: 100 Mbps Duplex: Full

  AutoCfg IPv6: FE80::20A:9CFF:FE52:4104/64
  IPv6 Address: FD01::1:B51A:E03C/64
  IPv4 Address: 10.1.6.230 Subnet Mask: 255.255.0.0
  IPv4 Gateway: 10.1.1.1
  DNS1: FD01::A01:585
  DNS2: 10.1.5.133

Static IPv4/IPv6 Settings
  IPv6 Address: FD01::A01:353/64
  IPv6 Gateway: ::
  IPv4 Address: 10.1.2.253 Subnet Mask: 255.255.0.0
  IPv4 Gateway: 10.1.1.1
  DNS1: 10.1.5.133
  DNS2: 10.1.5.134

DHCP Settings
  DHCP: Enabled
  FQDN: Enabled [sentry3-524104]
  Boot Delay: Enabled
  Static Fallback: Enabled

Network Services
  Telnet: Enabled Port: 23
  SSH: Enabled Port: 22 Auth: Password, Kb-Int
  HTTP: Enabled Port: 80
  SSL: Enabled Port: 443 Installed Cert: User Encrypted
  Access: Optional Stored Files: Cert & Key
  User Cert: Enabled User Passphrase: <set>
  SNMPv1/2: Enabled Port: 161 TrapPort: 162
  SNMPv3: Disabled Port: 161 TrapPort: 162
  FTP Server: Enabled Port: 21
  SPM Access: Enabled

Command successful
```

---

**NOTE:** The fields IPv4 Address, IPv4 Subnet Mask, IPv4 Gateway, DNS1, and DNS2 are equivalent to existing PDU IPv4 settings except that current network settings and static settings are displayed separately. This allows you to view both static configuration settings and active network settings that can be obtained using DHCP. The DNS addresses may be in IPv4 or IPv6 (based on RFC4291) format at this time.

---

## Chapter 2: Installation

Before installing your PT45 Commander, refer to the following lists to ensure that you have all the items shipped with the unit as well as all other items required for proper installation.

### Standard Accessories













- Mounting hardware:
  - Two removable flanges with M4 screws.
- Cables/Adapters:
  - RJ45 to RJ45 crossover cable.
  - RJ45 to DB9F serial port adapter (for connection to standard DB9M DTE serial port).
  - DB9F to DB25M modem cable.
- Pass-Thru cable/adapter kit (PT45-H016 - qty 0, PT45-H404 – qty 1, PT45-H808 - qty 2)
  - Four RJ12 to RJ12 crossover cables
  - RJ12 to DB25F adapter
  - RJ12 to DB25M adapter
  - RJ12 to DB9F adapter
  - RJ12 to DB9M adapter
- Separate power input cord (typically sold as a separate line item).
- Input power cord retention clip

### Additional Required Items

- Flathead and Phillips screwdrivers
- Screws, washers, and nuts to attach the Commander to your rack

## Safety Precautions

This section contains important safety and regulatory information that **must be reviewed** before installing and using the PT45 Commander.

	Only for installation and use in a Restricted Access Location in accordance with the following installation and use instructions.  <b>This equipment should only be installed by trained personnel.</b>	Destiné à l'installation et l'utilisation dans le cadre de Restricted Access Location selon les instructions d'installation et d'utilisation.  <b>Cet équipement est uniquement destiné à être installé par personnel qualifié.</b>	Nur für Installation und Gebrauch in eingeschränkten Betriebszonen gemäß der folgenden Installations- und Gebrauchsanweisungen.  <b>Dieses Gerät ist nur für den Einbau durch Personal vorgesehen.</b>
	This equipment is designed to be installed on a dedicated circuit. The power supply cord shall be a minimum of 1.5m (4.9ft) and a maximum of 4.5m (15ft). If using an extension power cord, the total length shall also be no more than the maximum allowed. The plug is considered the disconnect device and must be easily accessible.	Cet équipement a été conçu pour être installé que un circuit dédié. Le cordon d'alimentation doit être d'au moins 1,5M et un maximum de 4,5m. Si vous utilisez un cordon de rallonge, la longueur totale est également plus que le maximum autorisé. La prise est considérée comme un dispositif de coupure et doit être facilement accessible.	Die Geräte sind für eine Installation an einer fest zugeordneten Leitung ausgelegt. Die Stromzuleitung hat eine Mindestlänge von 1,5m, und höchstens 4,5m. Sollten Sie ein Verlängerungskabel, der Gesamtlänge auch nicht mehr als die maximal zulässig sein. Der Stecker dient zur Trennung vom Netz und muss einfach erreichbar sein.
	The dedicated circuit must have circuit breaker or fuse protection. PDUs have been designed without a master circuit breaker or fuse to avoid becoming a single point of failure. It is the customer's responsibility to provide adequate protection for the dedicated power circuit. Protection of capacity equal to the current rating of the PDU must be provided and must meet all applicable codes and regulations. In North America, protection must have a 10,000A interrupt capacity.	Le circuit spécialisé doit avoir un disjoncteur ou une protection de fusible. PDU's ont été conçus sans disjoncteur général ni fusible pour éviter que cela devienne un seul endroit de panne. C'est la responsabilité du client de fournir une protection adéquate pour le circuit-alimentation spécialisé. Protection de capacité équivalant à la puissance de l'équipement, et respectant tous les codes et normes applicables. Les disjoncteurs ou fusibles destinés à l'installation en Amérique du Nord doivent avoir une capacité d'interruption de 10.000 A.	Der feste Stromkreis muss mit einem Schutzscharter oder einem Sicherungsschutz versehen sein. PDU's verfügt über keinen Hauptschutzschalter bzw. über keine Sicherung, damit kein einzelner Fehlerpunkt entstehen kann. Der Kunde ist dafür verantwortlich, den Stromkreis sachgemäß zu schützen. Der Kapazitätsschutz entspricht der aktuellen Stromstärke der Geräte und muss alle relevanten Codes und Bestimmungen erfüllen. Für Installation in Nordamerika müssen Ausschalter bzw. Sicherung über 10.000 A Unterbrechungskapazität verfügen.
	Models with unterminated power cords: Input connector must be installed by qualified service personnel. Input connector rating must meet all applicable codes and regulations.	Modèles avec cordons d'alimentation non terminées: Le connecteur d'entrée doit être installé par un personnel qualifié. Entrée cote de raccordement doit respecter tous les codes et règlements électriques applicables.	Modelle mit nicht abgeschlossenen Netzkabel: Der Eingangsstecker darf nur von qualifiziertem Wartungspersonal installiert werden. Eingangsanschluss Bewertung müssen alle geltenden und verbindlichen Normen und Vorschriften entsprechen.
	Do not block venting holes when installing this product. Allow for maximum airflow at all times.	Ne bloquez pas les orifices d'aération lors de l'installation de ce produit. Permettre une circulation d'air maximale à tout moment.	Achten Sie darauf, dass keine Belüftungslöcher bei der Installation dieses Produkts. Damit für maximalen Luftstrom zu allen Zeiten.
	Installation Orientation: Vertical units are designed to be installed in vertical orientation.	Installation Orientation: Les unités vertical sont conçues pour être installées dans une orientation verticale.	Installationsausrichtung: Vertical Einheiten sind zur vertikalen Installation vorgesehen.
 	Always disconnect the power supply cord before servicing to avoid electrical shock. For products with two input power cords, both must be disconnected before servicing.	Toujours débrancher le cordon d'alimentation avant de l'ouverture pour éviter un choc électrique. Pour les produits avec deux cordons d'alimentation d'entrée, les deux doivent être déconnectés avant l'entretien.	Trennen Sie das Netzkabel, bevor Sie Wartungsarbeiten Öffnung einen elektrischen Schlag zu vermeiden. Für Produkte mit zwei Eingangsstromkabel, sowohl, müssen vor der Wartung abgeschaltet werden.
	<b>WARNING!</b> High leakage current! Earth connection is essential before connecting supply!	<b>ATTENTION!</b> Haut fuite très possible! Une connection de masse est essentielle avant de connecter l'alimentation !	<b>ACHTUNG!</b> Hoher Ableitstrom! Ein Erdungsanschluss ist vor dem Einschalten der Stromzufuhr erforderlich!
 	<b>WARNING!</b> Cx-xxE-x units double pole/neutral fusing	<b>ATTENTION!</b> Les unités Cx-xxE-x Double Pôle/Fusible sur le Neutre	<b>ACHTUNG!</b> Cx-xxE-x Zweipolige bzw. Neutralleiter-Sicherung
	<b>ATTENTION!</b> Observe precautions for handling Electrostatic Sensitive Devices.	Attention ! Respecter les mesures de sécurité en manipulant des dispositifs sensibles aux décharges électrostatiques.	Achtung! Vorsichtshinweise zur Handhabung elektrostatisch empfindlicher Geräte beachten.
	Products rated for 240/415VAC may be fitted with a plug that is rated for a higher voltage. Caution must be taken to assure that the rating of the unit and the supply voltage match.	Les produits prévus pour 240/415VAC peut être équipé d'un bouchon qui est conçu pour une tension plus élevée. Des précautions doivent être prises pour assurer que la cote de l'unité et la tension d'alimentation correspond.	Produkte die für 240/415VAC zugelassen sind können mit einem Stecker der für eine höhere Spannung ausgestattet sein. Vorsicht ist geboten, um sicherzustellen, dass die erlaubten Betriebswerte des Gerätes und der Versorgungsspannung zueinander passen.

## Installing the Power Input Retention Bracket

### To install the power input retention bracket:

1. Remove the two screws attaching the IEC 60320 C19 inlet to the enclosure.
2. Assemble and attach the retention bracket to the enclosure as shown.

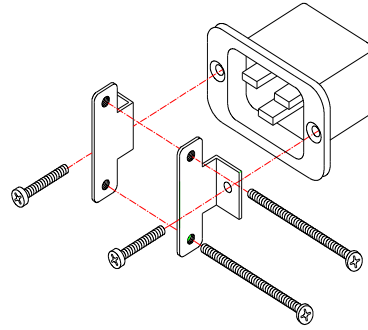

**Retention Bracket Assembly**

## Attaching Safety Earth Ground Connection

Server Technology PDUs are supplied with an external safety ground connection to provide an alternate ground path for fault currents, and to maintain the same ground reference between it and the equipment rack.

**NOTE:** The auxiliary external ground location may vary. Most PDUs will have it located near the power cord entry located near the  symbol.

### User-supplied materials:

- One 5 mm internal (or external) tooth star washer;
- One 4.0 mm<sup>2</sup> (10 AWG) wire with 5 mm ring terminal;
- One metric M5 x 6 mm coarse pitch screw.

### Instructions:

1. Connect one end of the ground wire to the equipment cabinet or local ground.
2. Locate the PDU external ground near the  symbol.
3. Connect the other end with a ring terminal and a M5 screw to the PDU external ground. To ensure proper grounding to the chassis, use a star washer between the ring terminal and the PDU.

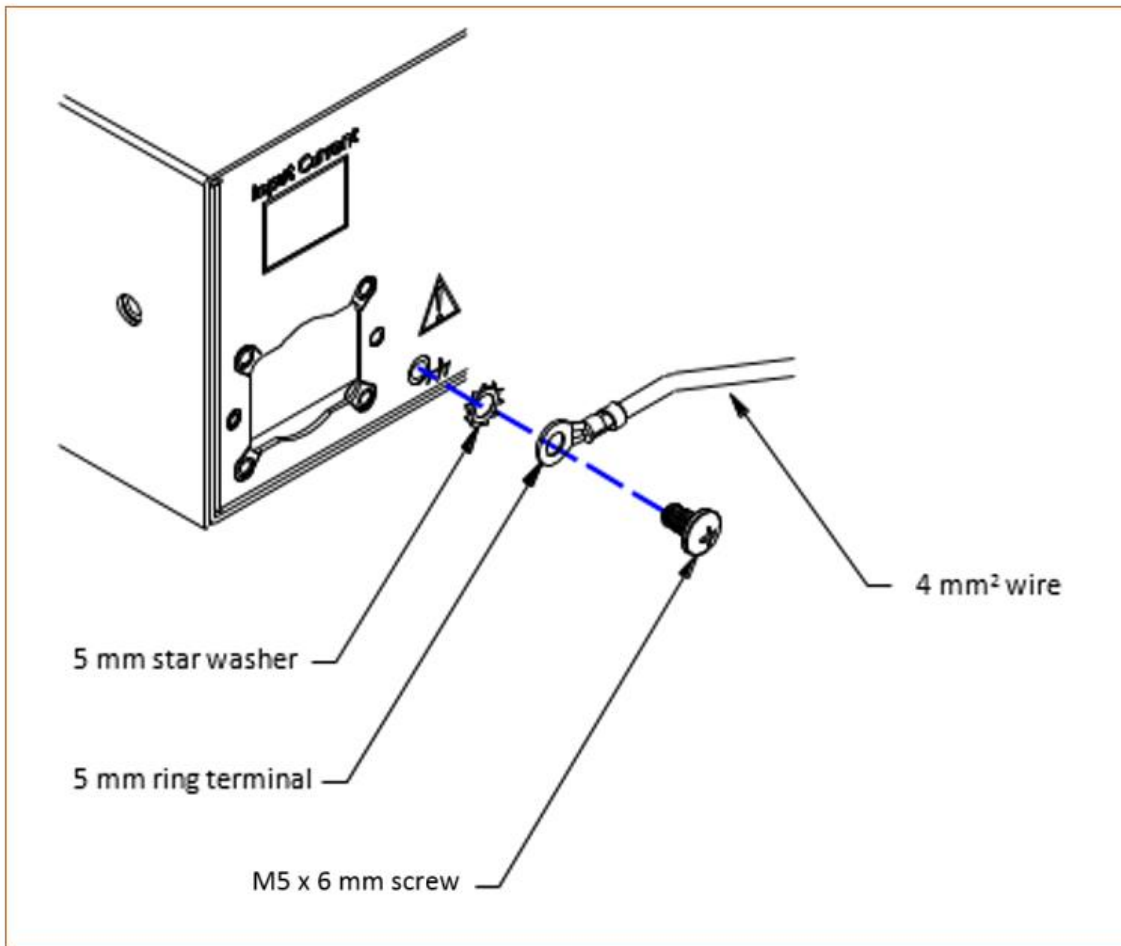

## Mounting the PDU

1. Select the appropriate bracket mounting points for proper mounting depth within the rack.
2. Attach the brackets to these mounting points with two screws for each bracket.
3. Install the enclosure into your rack, using the slots in each bracket. The slots allow about ¼ inch of horizontal adaptability to align with the mounting holes of your rack.

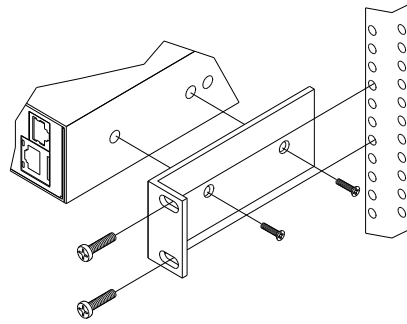

**Mounting Assembly**

---

**NOTE:** A mounting bracket kit for 23" wide racks or cabinets is available. Contact your Server Technology Sales Representative for more information.

---

## Connecting to the Power Source

### To attach a power cord to the unit:

1. Plug the female end of the power cord firmly into its connector at the base.
2. Use a screwdriver to tighten the two screws on the retention bracket.

### To connect to the power source:

Plug the male end of the power cord into the AC power source.

## Connecting Devices

1. Keep the device's on/off switch in the off position until after it is plugged into the outlet, or log in to the Commander and turn the Intelligent Power Module ports off before connection is made. After connecting the Intelligent Power Module (IPM), turn them on using the Commander.
2. Connect the Intelligent Power Module(s) to the Commander using the RJ12 crossover cable(s) supplied with the IPM.
3. Connect IPMs to the outlets.  
For IPMs with retention clips:  
IPMx-R-x: Insert the power cord and snap the clip over the cord.  
PM20-x-x: Insert the power cord and tighten the two screws on the retention bracket
4. Connect devices to the Intelligent Power Modules.  
For IPMs with retention clips:  
IPMx-x-x: Insert the device's power cord and snap the clip over the cord.  
PM20-x-x: Insert the device's power cord and tighten the two screws on the retention bracket
5. Connect devices to the Pass-Thru ports.

## Connecting the Sensors

The PT45 is equipped with two mini RJ11 temperature/humidity ports for attachment of the temperature/humidity sensors. Attach the mini RJ11 plug of the sensor(s) to the appropriate ports.

## Connecting to the Unit

### Serial (RS232) port

The Commander is equipped with an RJ45 Serial RS-232 port for attachment to a PC or networked terminal server using the supplied RJ45 to RJ45 crossover cable and RJ45 to DB9F serial port adapter as required. For more information about the Serial RS-232 port, see Data Connections in Appendix C: Technical Specifications.

## **Ethernet port**

The Commander is equipped with an RJ45 10/100Base-T Ethernet port for attachment to an existing network. This connection allows access to the Commander via Telnet or HTML.

The Commander is configured with the following network defaults to allow unit configuration out-of-the-box through either Telnet or HTML:

- IP address: 192.168.1.254
- Subnet Mask: 255.255.255.0
- Gateway: 192.168.1.1

The local PC network connection must be configured as noted below:

---

**NOTE:** Contact your system administrator for instructions in reconfiguring the network connection. Reconfiguration of your network connection may require a restart to take effect.

---

- IP address: 192.168.1.x (where x is 2-253)
- Subnet Mask: 255.255.255.

## **Modem port**

The Commander is equipped with a DB9 male Modem serial port for connection to an external modem using the supplied DB9 female to DB25 male serial cable. For more information about the modem port, see Data Connections in Appendix C: Technical Specifications.





# Chapter 3: Operations

<b>INTERFACES</b>	<b>19</b>
Outlet Naming and Grouping	19
<i>Models with a Single Power Infeed</i> .....	19
<i>Models with Multiple Power Infeeds</i> .....	19
Usernames and Passwords	19
<b>WEB INTERFACE</b>	<b>20</b>
Logging In	20
System Summary	21
Outlet Control	24
<i>Individual</i> .....	24
<i>Group</i> .....	24
Power Monitoring	25
<i>Input Feeds</i> .....	25
<i>System</i> .....	25
<i>UPS</i> .....	25
Environmental Monitoring	25
<i>Sensors</i> .....	25
Shutdown	26
<i>Outlets</i> .....	26
Configuration	26
<i>System</i> .....	26
<i>Network</i> .....	28
<i>Telnet/SSH</i> .....	30
<i>HTTP/SSL</i> .....	30
<i>Serial Ports</i> .....	31
<i>Towers</i> .....	33
<i>Input Feeds</i> .....	33
<i>UPS</i> .....	33
<i>Outlets</i> .....	34
<i>Groups</i> .....	34
<i>Users</i> .....	35
<i>FTP</i> .....	36
<i>SNTP/Syslog</i> .....	37
<i>SNMP/Thresholds</i> .....	38
<i>LDAP</i> .....	40
<i>TACACS+</i> .....	42
<i>RADIUS</i> .....	43
<i>SMTP/Email</i> .....	44
<i>Features</i> .....	45
Tools	45
<i>Ping</i> .....	45
<i>Change Password</i> .....	45
<i>Firmware</i> .....	45
<i>View Log</i> .....	45
<i>Restart</i> .....	46
<b>COMMAND LINE INTERFACE</b>	<b>47</b>
Logging In	47
Operations Commands	50
Administration Commands	55
<i>User Administration</i> .....	55
<i>Outlet Administration</i> .....	58
<i>Input Feed Administration</i> .....	60
<i>Tower Administration</i> .....	61
<i>Group Administration</i> .....	62
<i>Environmental Monitor Administration</i> .....	63
<i>Serial Port Administration</i> .....	64
<i>System Administration</i> .....	67
<i>TCP/IP Administration</i> .....	75
<i>HTTP Administration</i> .....	78

<i>Telnet Administration</i> .....	79
<i>FTP Administration</i> .....	80
<i>SNTP Administration</i> .....	82
<i>UPS Administration</i> .....	83

## Interfaces

The PT45 Commander unit has two interfaces: the Web interface accessed via the HTTP-enabled Ethernet connections, and the Command Line Interface (CLI) for serial and Telnet connections.

### Outlet Naming and Grouping

#### Models with a Single Power Infeed

Absolute names are specified by a period (.) followed by a tower letter and outlet number. The tower letter for the PT45 unit is A and the tower letter for the optional Expansion Module is B.

#### Models with Multiple Power Infeeds

For units with multiple infeed connectors, absolute names are specified by a period (.) followed by the tower letter, *the infeed letter* and outlet number.

**Example:** The absolute name for outlet 8 on the B infeed of tower A is .AB8.

Outlets may also be included in one or more named groups of outlets, enabling you to issue a command that affects all outlets in a named group.

### Usernames and Passwords

The PT45 unit has one predefined administrative user account (username/password: admn/admn), and supports a maximum of 112 defined user accounts.

---

**NOTE:** For security, Server Technology recommends first creating a new administrative user account with administrative rights before removing the default account **admn**.

---

Only an administrative-level user can perform operations such as creating/removing user accounts and command privileges, changing passwords, and displaying user information. An administrator can also view the status of all sensors and power inputs.

Usernames can contain from 1-16 characters and are not case sensitive; spaces are not allowed. Passwords can contain up to 16 characters, and are case sensitive.

## Web Interface

The Web Interface provides web-based access to the firmware. The interface is designed with three major sections, illustrated below.

1. System Header: Shows device description, unit location, IP address and user/access information.
2. Navigation Bar: Provides access to unit configuration, control action, or status page.
3. Details Area: Current control/status information based on the page selected from the navigation bar.

This example shows the **Outlet Control > Individual** page

The screenshot displays the 'Sentry Switched CDU' web interface. The top header (1) shows 'Sentry Switched CDU' and 'Outlet Control - Individual'. The navigation bar (2) on the left includes 'System', 'Outlet Control', 'Individual', 'Group', 'Power Monitoring', 'Configuration', and 'Tools'. The details area (3) features a table for 'Individual Outlet Control' with columns for 'Outlet ID', 'Outlet Name', 'Outlet Status', 'Control State', and 'Control Action'. The table lists four outlets (A1-A4) with 'Off' status and 'None' control actions. Below the table is a 'Global Control Action' dropdown set to 'None'.

Outlet ID	Outlet Name	Outlet Status	Control State	Control Action
A1	TowerA_Outlet1	Off	Off	None
A2	TowerA_Outlet2	Off	Off	None
A3	TowerA_Outlet3	Off	Off	None
A4	TowerA_Outlet4	Off	Off	None

### Firmware Web Interface for the PT45 Commander

#### Logging In

Logging in through Web requires directing the Web client to the configured IP address of the unit.

#### **To log in by Web interface:**

In the login window, enter a valid username and password and press **OK**.

If you enter an invalid username or password, you will be prompted again.

You are given three attempts to enter a valid username and password combination. If all three fail, the session ends and a protected page will be displayed.

---

**NOTE:** The default username/password is **admn/admn**.

---

## System Summary

The System Summary is typically displayed as the default page at user login to the firmware Web Interface. If you do not have environmental monitor access for a PT45, your default page at login will be the Outlet Control page (shown in the previous screen example).

Both the System Summary page and the Outlet Control page display automatically at login and do not require enabling.

The System Summary page contains general system, line, humidity, and temperature status information. The color-coded sensor graphs shown in the example below provide a quick and efficient real-time view for monitoring environmental conditions in your PT45 network.

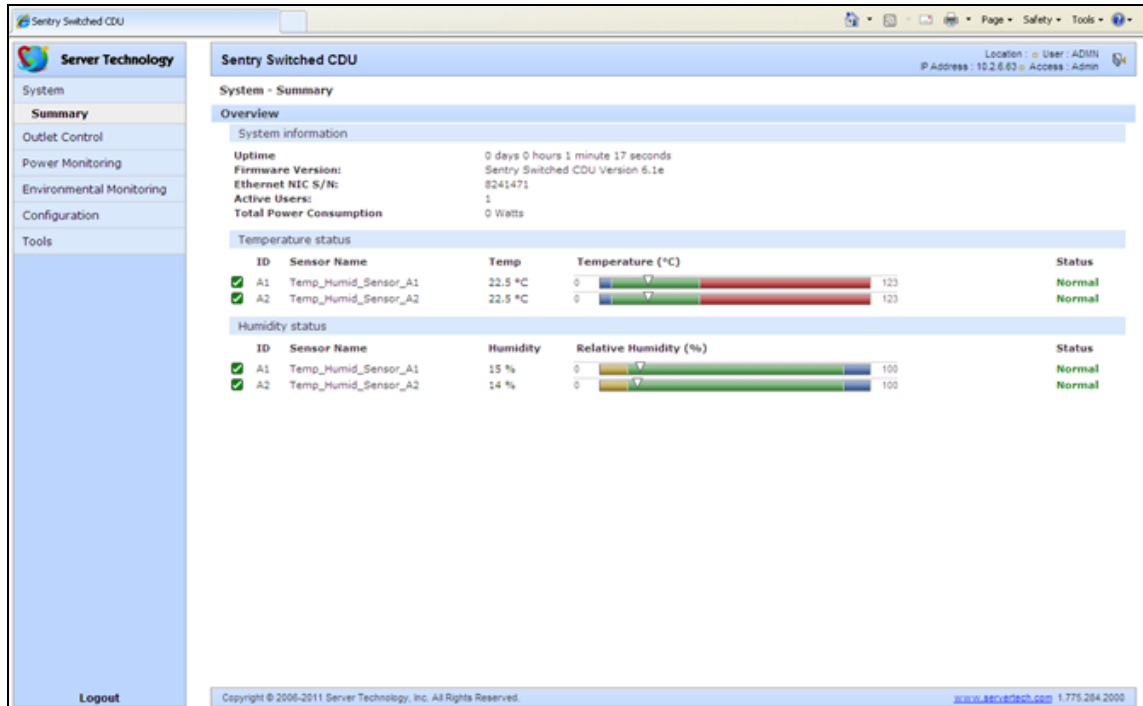

### Example of System Summary Page

The System Summary page displays precise current and system power consumption in your PT45 network. Dynamic updates (without a full page refresh) allow you to assess critical system statistics with close to instantaneous feedback. This performance is useful for monitoring new installation or power distribution changes in high-density computing environments. Power system administrators can also quickly identify thermal and humidity concerns that might otherwise escalate into costly infrastructure repairs if left unchecked.

As long as the System Summary page is active, the sensor graphs are continually updating system statistics and threshold values. The data with the most impact on the system is displayed to reduce your analysis and troubleshooting time. You can quickly analyze and correct a PT45 if a sudden operating condition affects your device network.

**NOTE:** Because the System Summary page continually requests updated status information from the PT45, the page does not time-out. You will need to navigate to another page or manually log off.

### System Information

**Uptime:** Displays the cumulative time the PT45 has been up and running since the last unit restarted. Uptime shows continuous, real-time system updates with an approximate 5-second automatic refresh. A manual refresh of the System Summary page is not required.

**Firmware Version:** Shows the current firmware version.

**Ethernet NIC S/N:** Displays the PT45 serial number derived from the Ethernet NIC.

**Active Users:** Displays the number of active user sessions accessing the firmware. These sessions include serial, Telnet, SSH, and Web sessions. Active Users also shows sessions that an unauthorized user may be attempting to access. The number shown in Active Users changes instantly as the number of active user sessions change.

---

**NOTE:** Depending on your web browser, multiple web accesses from the same machine are often treated as one user.

---

## Temperature Status

The Temperature Status graph displays a blinking error whenever temperature exceeds the low or high threshold. The PT45 will continue to display this state until the condition changes or the problem has been resolved.

For the temperature sensor, the default range of low/high temperature values is 5°-45° C (41°-115° F).

Up to four sets of dual temperature/humidity sensors can be displayed in this graph for a total of eight possible temperature sensor graphs. A thin blue line separates each set based on the tower or environmental monitor.

---

**NOTE:** The temperature threshold values are user-defined. You must configure these threshold values on the [SNMP/Thresholds page](#) or the [Command Line Interface \(CLI\)](#).

---

## Humidity Status

The Humidity Status graph displays a blinking error whenever humidity exceeds the low or high threshold. The PT45 will continue to display this state until the condition changes or the problem has been resolved.

For the humidity sensor, the default range of low/high humidity percentage is 0-100% (relative humidity).

Up to four sets of dual temperature/humidity sensors can be displayed in this graph for a total of eight possible humidity sensor graphs. A thin blue line separates each set based on the tower or environmental monitor.



---

**NOTE:** The humidity threshold values are user-defined. You must configure these threshold values on the [SNMP/Thresholds page](#) or the [Command Line Interface \(CLI\)](#).

---

## Field Descriptions

The following fields and icons are viewed left to right for Temperature Status and Humidity Status:

**Icon:** Provides quick viewing of current operational state: Information , Warning  and Critical .

**ID:** Device input feed or sensor identifier.

**Name:** Descriptive, user-defined name for each input infeed or sensor.

**Load, Temp, Humidity:** Current state of the reported input load (in amps), current temperature, or current percentage of relative humidity.









**Low Limit:** Displays the user-defined low limit of the load, temperature, or humidity graph. These values depend on the sensor limited and cannot be set by the user. For example, a 0°C low limit would be displayed as  for a temperature sensor graph in Celsius.

**Sensor Graph and Level Indicator:** The horizontal sensor graph shows current operating conditions in color-coded segments. See the section below, “Sensor Graph Color Coding” for details. The level indicator  appears across the graph to indicate the relative position of the current data value with respect to the minimum (low limit) and maximum (high limit) values displayed at the left and right of the graph.

**High Limit:** Displays the high limit of the load, temperature, or humidity graph. These values depend on the sensor limits and cannot be set by the user. For example, a 100°C high limit would be displayed as  100 for a temperature sensor graph in Celsius.

**Status:** One of several operating conditions:

### System Summary – Status Descriptions

Icon	Status	Description
	Reading	Unit is reading a new or restored sensor.
	Normal	Indicates normal operation.
	Load High	Infeed current load exceeds present High threshold.
	Over Load	Infeed current load exceeds the measurable range for the infeed.
	Temp Low	Current temperature falls below present Low threshold.
	Temp High	Current temperature exceeds present High threshold.
	Humid Low	Current percentage of relative humidity falls below present Low threshold.
	Humid High	Current percentage of relative humidity exceeds present High threshold.
	Lost	The connection was lost to a sensor that was previously detected and the sensor is pulled from the original environment monitoring statistics. There is no data to report, the graph is meaningless, and the threshold settings remain displayed but are grayed.

### Sensor Graph Color-Coding

The following colors change dynamically on the sensor graphs to communicate operating conditions:

#### *Line (Load) Status:*

Green = Normal

Yellow = High load (load configured by user)

Red = Overload (based on device characteristics)

User configures load capacity at **Configuration > SNMP/Thresholds > Input Feed Traps and Thresholds**

#### *Temperature Status:*

Blue = cold; low temperature (threshold configured by user)

Green = acceptable temperature range

Red = hot; high temperature (threshold configured by user)

User configures low/high temperature thresholds at **Configuration > SNMP/Thresholds > Sensor Traps and Thresholds**

#### *Humidity Status:*

Blue = wet; high humidity (threshold configured by user)

Green = acceptable percentage of relative humidity

Yellow = dry; low humidity (threshold configured by user)

User configures low/high relative humidity thresholds at **Configuration > SNMP/Thresholds > Sensor Traps and Thresholds**

## Logical Group Separators

Logical groups are separated by a thin blue line on the System Summary page as shown in the following example between Tower A\_InfeedA and Tower B\_InfeedA:

Line status						
	ID	Input Feed Name	Load	RMS Current (Amps)		Status
✓	AA	TowerA_InfeedA	0.00 A	0		21 Normal
<hr/>						
✓	BA	TowerB_InfeedA	0.25 A	0		21 Normal

This grouping includes master/link units in addition to some branched units.

Up to three blue line dividers can be displayed on the System Summary page between all sensor groups.

## Outlet Control

The Outlet Control section offers access to the Individual and Group outlet control pages. From the Individual and Group pages, the user can review and manipulate power control functions for all outlets and groups assigned to the current user. Both pages include the outlet's absolute and descriptive names, the Outlet Status reported to the PT45 by the outlet, the current Control State being applied by the unit, and the outlet load in amperes.

Available outlet and group power states may be set to on, off or reboot.

### Individual

The Individual outlet control page displays all outlets assigned to the current user. The user may apply on, off or reboot actions to individual, multiple or all accessible outlets.

#### To apply actions to individual or multiple outlets:

In the Individual Outlet Control section, select the desired action from the Control Action drop-down menu for each individual outlet to be changed, and click **Apply**.

#### To apply an action to all outlets:

In the Global Control section, select the desired action from the Control Action drop-down menu and click **Apply**.

### Group

The Group outlet control page displays all groups assigned to the current user, as well as the outlets for each group.

#### To select a group:

Select the group name from the drop-down menu and click **Select**. The page will refresh to display all outlets associated to the selected group name.

#### To apply an action to a group:

Select the desired action from the drop-down menu and click **Apply**.



## Outlet State/Control State Field Values

Outlet State	Control State	Description
On	On	Outlet is on
Off	Off	Outlet is off
Off	Pend On	Outlet is off and about to turn on in response to a sequence timer
Off	Reboot	Outlet is off and a Reboot action has been initiated
On	Idle On	A restart has occurred: Last Control State has been maintained
Off	Idle Off	A restart has occurred: Last Control State has been maintained
On	Wake On	A power-loss has occurred: Wakeup State has been applied
Off	Wake Off	A power-loss has occurred: Wakeup State has been applied
On/Wait	Off	Outlet state in transition: Re-query of outlet status required
Off/Wait	On	Outlet state in transition: Re-query of outlet status required
On/Error	varies	Error State: Outlet should be off, but current is sensed at the outlet
Off/Error	varies	Error State: Outlet should be on, but no current is sensed at the outlet
Off/Fuse	On	Outlet should be on, but a blown fuse has been detected
No Comm	varies	Communication to the outlet has been lost *

\* Control State will be applied when communication is re-established.

## Power Monitoring

### Input Feeds

The Input Feeds page displays:

- The absolute and descriptive names of the infeed
- Infeed status
- Input/branch phase load in amperes
- Input Voltage
- Calculated power usage in Watts.

Monitor pages (like the Input Feeds page) refresh occasionally to reflect current PT45 status.

### System

The System page displays:

- Calculated power usage for ALL infeeds in Watts
- Configured total system area in square feet.
- Calculated power usage in Watts/square foot.

Monitor pages (like the System page) refresh occasionally to reflect current PT45 status.

### UPS

The UPS page displays the following information for each UPS device associated with the PT45 unit:

- Status
- Voltage
- Hostname/IP address

Monitor pages (like the UPS page) refresh occasionally to reflect current PT45 status.

## Environmental Monitoring

### Sensors

The Sensors page displays:

- Temperature/humidity sensor's absolute and descriptive names
- Temperature/humidity sensor readings in degrees Celsius and percentage of relative humidity

Monitor pages (like this Sensors page) refresh occasionally to reflect current PT45 status.

## **Shutdown**

The Shutdown section offers access to all Remote Shutdown configuration options. This section is available to administrative level users only. For more information and configuration requirements, see the Remote Shutdown section.

### **Outlets**

#### **Enabling or disabling Remote Shutdown support:**

Select or deselect outlets to enable/disable Remote Shutdown support for in the Shutdown/Delay field and click **Apply**.

#### **Setting the Remote Shutdown delay:**

Enter the shutdown delay (in seconds) in the outlet Shutdown/Delay field and click **Apply**. Valid range is 1-900 seconds.

#### **Editing the target server's Hostname/IP address:**

In the outlet Hostname/IP field, enter an IP address or Hostname and click **Apply**.

#### **Enabling or disabling shutdown script support:**

Select or deselect outlet to enable/disable shutdown script support for in the Script/Delay column and click **Apply**.

#### **Setting the shutdown script delay:**

Enter the shutdown delay (in minutes) in the outlet Script/Delay field and click **Apply**.

## **Configuration**

The Configuration section offers access to all unit configuration options. This section is available to administrative level users only.

### **System**

The System configuration page is used for reference of system information such as Ethernet NIC Serial Number, Ethernet MAC address and system firmware and hardware revisions as well as assignment and maintenance of other system wide configurations.

For descriptive names, up to 24 alphanumeric and other typed characters (ASCII 33-126 decimal) are allowed; spaces are not allowed.

---

**NOTE:** Spaces may be used for the location description only. .

---

#### **Creating a pre-login banner:**

Click on the **Login Banner** link.

On the subsequent Login Banner page, enter a pre-login banner and press **Apply**.

---

**NOTE:** The pre-login banner may be up to 2070 characters in length and is displayed prior to the login prompt. If left blank, no system banner will be displayed prior to login prompt.

---

The Login Banner displays the following Characters Remaining box to show you in real-time as you type how many of the 2069 maximum characters are still available for you to complete your banner. The box adjusts dynamically as you type or delete characters.

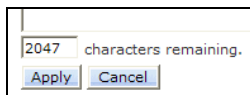

If you reach the maximum 2069 characters, the box displays “-1”. To clear your entry and start over, click **Cancel**.

#### **Creating a descriptive system location name:**

Enter a descriptive name and press **Apply**.

### Setting the outlet sequence order:

The PT45 lets you configure the power-on sequence of outlets.

The Normal option powers-on outlets in ascending numeric order by outlet number, for example, from outlet 1-8. The Reversed option powers on outlets in descending order by outlet number; for example, from outlet 8-1.

The Reversed option is useful when the PT45 is mounted with inverted orientation and the last outlet (in this example, outlet 8) is in the first position.

From the Outlet Sequence Order drop-down menu, select Normal or Reversed, and click **Apply**

### Enabling or disabling strong password requirements:

The PT45 supports enforcement of strong passwords for enhanced security. When enabled, all new passwords must be a minimum of 8 characters in length with at least one uppercase letter, one lowercase letter, one number and one special character.

#### *Acceptable strong passwords:*

```
n0tOnmyw@tch  
john2STI?  
H3reUgo!
```

---

**NOTE:** Strong password requirements also enforce a minimum change of four character positions when defining new strong passwords.

---

Select **Enabled** or **Disabled** from the Strong Passwords drop-down menu and click **Apply**.

---

**NOTE:** The strong password requirement is applied against all new passwords.

---

### Enabling or disabling the external reset button:

Select **Enabled** or **Disabled** from the External Reset Button drop-down menu and click **Apply**.

### Setting the temperature scale:

Select **Celsius** or **Fahrenheit** from the Temperature Scale drop-down menu and click **Apply**.

### Setting the system area (footprint):

Enter a system area value in the Area (Footprint) field and click **Apply**.

### Setting the system area unit of measure:

Select the unit of measure from the Unit of Measure drop-down list and click **Apply**.

### Setting the system input power factor:

The Power Factor value is used to provide calculated power usage displayed in the Power Monitoring pages. Type a numeric value in the Power Factor field from .50 to 1.00, and click **Apply**.

### Setting the 3-phase load out-of-balance threshold:

This setting is used for devices with 3-phase input voltages to notify of a system imbalance between the three phases of power.

In the 3-Phase Load Out-of-Bounds Threshold field, enter a value from 0 to 100% and click **Apply**.

### Setting the 3-phase load out-of-balance alerting:

This setting enables/disables the sending of an alert when the current on the lines of a 3-phase system are past a pre-set threshold (percentage) and are out-of-balance between the three phases of power.

From the 3-Phase Load Out-of-Balance Alerting drop-down menu, select **Enabled** or **Disabled**, and click **Apply**.

---

#### **NOTES:**

- When a device with 3-phase input voltage is out-of-balance, efficiency is reduced and the unit is prevented from reaching maximum capacity. When an alert for the out-of-balance condition is received (if the alerting feature is enabled), it may be necessary to adjust distribution of the loads.
  - For 3-phase systems, if the Out-of-Balance Alerting feature is enabled, and the system goes into a load out-of-balance condition, the Tower Status field on the “Power Monitoring – System” web page will display the alert “3ph Out-of-Balance”, unless there is a higher priority tower error state to report.
-

### Configuring the Command Line Interface (CLI) session timeout:

Type a timeout period (in minutes) in the CLI Session Timeout field, and click **Apply**.

The valid timeout range is 1 to 1440 minutes (24 hours); the default is 5 minutes.

### Configuring the web session (Web Interface) timeout:

Enter a timeout period (in minutes) in the Web Session Timeout field.

The valid timeout range is 1 to 1440 minutes (24 hours); the default is 5 minutes.

### Creating a descriptive unit name:

Click on the **Tower Names** link.

On the subsequent Tower Names page, enter a descriptive name and click **Apply**.

### Creating a descriptive input feed name:

Click on the **Input Feed Names** link.

On the subsequent Input Feed Names page, enter a descriptive name and click **Apply**.

### Creating a descriptive outlet name:

Click on the **Outlet Names** link which will open the Outlets configuration page. For more information about creating descriptive outlet names, see the Outlets section.

### Creating a descriptive serial port name:

Click on the **Serial Port Names** link which will open the Serial Ports configuration page. For more information about creating descriptive serial port names, see the Serial Ports section in this manual.

### Creating a descriptive Environmental Monitor name:

Click on the **Environmental Monitor Names** link.

On the subsequent Environmental Monitor Names page, enter a descriptive name and click **Apply**.

### Creating descriptive sensor names:

Click on the **Sensor Names** link.

On the subsequent Sensor Names page, enter a descriptive name, and click **Apply**.

## Network

The Network configuration page allows the administrator to maintain the network interface by determining IPv6 and IPv4 status, network state, IP address, gateway, subnet mask, primary/secondary DNS addresses, and the necessary settings and options for DHCP.

---

**NOTE:** For maximum backward compatibility, the default network mode is “IPv4 only”.

---

### Network:

The Network drop-down menu determines the acquisition method used for the protocol stack, IPv4 address, and IPv6 address. From the Network drop-down menu, select the acquisition method for your network (Disabled, IPv4 only, or Dual IPv6/IPv4), and click **Apply**.

### State:

The view-only State field shows the current IPv6/IPv4 network status and can display any of the following values:

#### Current Network States

• Acquiring	• Disabled	• Disconnected
• DHCP IPv4	• DHCP IPv6	• DHCP IPv6/IPv4 (both available)
• IPv4 Failed (Static IPv4 problem)	• IPv6 Failed (Static IPv6 problem)	• Static IPv4
• Static IPv6	• Static IPv6/IPv4 (both available)	• Unknown

Additional network communication values are displayed for viewing only: Link, Speed, Duplex, and Negotiation. Also displayed for viewing are the IPv6 and IPv4 IP address, subnet mask, gateway, and primary/secondary DNS addresses.

## Setting the IPv6 or IPv4 static IP address, gateway, subnet mask, or DSN address:

In the appropriate fields, type the IP address, gateway, subnet mask, or DNS address, and click **Apply**.

---

**NOTE:** IPv6 address formats are accepted in the IPv6 Address field and IPv6 Gateway field. IPv4 formats are accepted in the IPv4-named Address, Subnet Mask, and Gateway fields.

---

## Enabling Dynamic Host Configuration Protocol (DHCP):

### Enabling Dynamic Host Configuration Protocol (DHCP):

To enable DHCP, check the Enable checkbox. To disable DHCP, uncheck (clear) the checkbox.

Click **Apply**.

### Setting the fully-qualified domain name (FQDN):

To enable FQDN, check the Enable checkbox and accept the default name “sentry3-521384” (or type a different name). To disable FQDN, uncheck (clear) the checkbox.

Click **Apply**.

### Enabling the DHCP boot delay:

To enable the boot delay, check the Enable checkbox. To disable the boot delay, uncheck (clear) the checkbox.

Click **Apply**.

Enabling the Boot Delay option gives the unit approximately 100-seconds to establish a connection through a DHCP server. This interval allows various network component activities to occur as the unit powers up (such as obtaining SNTP time stamps for logging). This is the default state.

Disabling the Boot Delay option forces the PT45 to boot after approximately 5-seconds regardless of the DHCP acquisition state. This speeds up a boot when a DHCP server is connected to one of the outlets in the unit. In this configuration, SNMP traps, SNTP, and other protocols will not be available until a DHCP address has been resolved.

---

#### NOTES:

- The Boot Delay option executes only when DHCP is enabled.
  - The firmware can detect network link integrity and will wait for network connection. This means that if the network is not currently connected, the enabled Boot Delay option will be ignored.
- 

### Enabling static address fallback:

---

**NOTE:** The Static Address Fallback option executes only when DHCP is enabled.

---

To enable static address fallback, check the Enable checkbox. To disable, uncheck (clear) the checkbox.

Click **Apply**.

- Enabling the Static Address Fallback option informs the PDU to automatically fall back to a static address if a DHCP server does not respond after 100-seconds. This is the default state.
- Disabling the Static Address Fallback option generates DHCP server requests until the PDU obtains a dynamic address.

---

**NOTE:** If the DHCP server boot time is excessive, you may need to disable the DHCP Static Address Fallback option.

---

## Network defaults

The PT45 is configured with the following network defaults to allow unit configuration out-of-the-box through either Telnet or Web:

- IP address: 192.168.1.254
- Subnet Mask: 255.255.255.0
- Gateway: 192.168.1.1

The initial local PC network connection must be configured as noted below:

---

**NOTE:** Contact your system administrator for instructions in reconfiguring the network connection. Reconfiguration of your network connection may require a restart to take effect.

---

- IP address: 192.168.1.x (where x is 2-253)
- Subnet Mask: 255.255.255.0

---

**NOTE:** The unit must be restarted after network configuration changes. See the “Performing a Warm Boot” section.

---

## Setting the IP address, subnet mask, gateway, or DNS address:

In the appropriate field, enter the IP address, subnet mask, gateway address, or DNS address and click **Apply**.

## Telnet/SSH

The Telnet/SSH configuration page enables or disables Telnet and SSH support and configures the port number that the Telnet or SSH server watches.

### Enabling or disabling Telnet or SSH support:

Select **Enabled** or **Disabled** from the appropriate Server drop-down menu and click **Apply**.

### Changing the Telnet or SSH server port number:

In the appropriate Port field, enter the port number and click **Apply**.

### Enabling or disabling SSH server authentication methods:

The SSH server supports the Password and the Keyboard-Interactive authentication methods for security.

Password is an authentication method in which the SSH client gathers username/password credentials and makes the authentication request to the SSH sever with the credentials. The Password method is controlled by the SSH client.

Keyboard-Interactive is an authentication method in which the SSH server controls an information field followed by one or more prompts requesting credential information from the SSH client. The client gathers credential information keyed-in by the user and sends it back to the server. The Keyboard-Interactive method is controlled by the SSH server.

Individual enabling and disabling of the Password and Keyboard-Interactive authentication methods are supported to allow an SSH client to be forced to use a specific method. Although both methods are available, by enabling the Keyboard-Interactive method and disabling the Password method, the SSH client is forced to used Keyboard-Interactive, which is required to display the login banner.

---

**NOTE:** At least one authentication method must be enabled.

---

Select the **Password** checkbox and/or the **Keyboard-Interactive** checkbox and click **Apply**.

## HTTP/SSL

The HTTP/SSL configuration page specifies settings that enable or disable HTTP and SSL support, configures the port number that the HTTP server watches and responds to, determines the SSL access level, and sets options for the Sentry Power Manager (SPM) product.

### Enabling or disabling HTTP or SSL support:

Select **Enabled** or **Disabled** from the appropriate Server drop-down menu and click **Apply**.

---

**NOTE:** HTTPS must be used for secure website connections.

---

## Changing the HTTP server port number:

In the HTTP Port field, enter the port number and click **Apply**.

## Setting SSL access level:

The PT45 SSL supports configuration of SSL connections as being either optional or required. The default access level is set to optional.

- Optional – Both non-secure (HTTP) and SSL encrypted connections (HTTPS) are allowed access.
- Required – ONLY SSL encrypted connections (HTTPS) are allowed access.

Select **Optional** or **Required** from the Secure Access drop-down menu and click **Apply**.

## Setting the Sentry Power Manager (SPM) options:

The Sentry Power Manager (SPM) is Server Technology's enterprise management software product for the data center. The configuration options provided allow you to enable/disable SPM and reset the SPM password to its default.

---

**NOTE:** The SPM options only apply if you are currently using Server Technology's SPM software. In addition, the SPM options are only available on the HTTP/SSL web page. There are no equivalent SPM options on the Command Line Interface (CLI).

---

### *SPM Secure Access:*

If your operation does not currently use SPM software, you can disable SPM Secure Access. However, if disabled, the PT45 will not be able to use the SPM suite of secure network capabilities or the advanced remote configuration.

Select **Enabled** or **Disabled** from the SPM Secure Access drop-down menu and click **Apply**.

---

**NOTE:** Both HTTP and SSL must be enabled or the SPM Secure Access option will not be permitted. When SPM Secure Access is permitted, the default is **Enabled**.

---

### *SPM Password:*

Each PT45 has a default unique SPM password that is used to communicate between SPM and the PT45. When SPM discovers a unit in the network, SPM changes this password into a different unique password for added security. The SPM then continues to manage or alter these passwords as required for system security.

If a unit is relocated or swapped from the system after a password was generated, the SPM may not be able to reestablish a connection to the unit. The SPM Password checkbox allows you to reset this back to the internal default password of the PT45 so the SPM can re-discover the device and add it to the system. Once the unit has been acquired by SPM, no further action is necessary.

To reset the password, check SPM Password and click **Apply**. If SPM communication has already been established, do not reset the password.

## **Serial Ports**

The Serial Ports configuration page is used for maintenance of the serial port.

---

**NOTE:** Pass-Thru connections may only be initiated from the command line interface via a Telnet/SSH session.

---

## Setting the data-rate for all serial ports:

Select the serial port data-rate from the drop-down menu and click **Apply**.

## Setting the serial port timeout value:

Enter the timeout value (in minutes) in the Connection Timeout field and click **Apply**.

## Creating a descriptive serial port name:

Click on the **Edit** link in the Action column next to the port to be configured.

On the subsequent Serial Port Edit page, enter a descriptive name up to 24 alphanumeric and other typed characters - (ASCII 33 to 126 decimal) are allowed; spaces are not allowed. Click **Apply**.

## Enabling or disabling serial port active signal checking:

Click on the **Edit** link in the Action column next to the port to be configured.

On the subsequent Serial Port Edit page, select **On** or **Off** from the DSR Check drop-down menu and click **Apply**.

## Enabling or disabling the Command Line Interface (CLI):

This option enables or disables availability of the CLI for issuing action commands to the PDU. If disabled, only the firmware Web user interface will be available.

Click on the **Edit** link in the Action column next to the port to be configured.

On the following Serial Ports Edit page, select **Enabled** or **Disabled** from the CLI drop-down menu and click **Apply**.

## Enabling or disabling the Serial Command Protocol (SCP):

This option allows SCP functions to be enabled or disabled for a specific serial port.

Click on the **Edit** link in the Action column next to the port to be configured.

On the following Serial Ports Edit page, select **Enabled** or **Disabled** from the SCP drop-down menu and click **Apply**.

---

### NOTES:

- Upon a coldboot of the system, if the Coldboot Alert feature is enabled, the system will send a ½ second RS-232 break out to any SCP-enabled serial ports.
- The SCP option must be enabled to use the Bluetooth Android solution.

---

## Enabling or disabling the Serial Command Protocol (SCP) emulation:

This option notifies SCP of an MRV device on a specific serial port.

Click on the **Edit** link in the Action column next to the port to be configured.

On the following Serial Ports Edit page, select **None** or **MRV** from the SCP Emulation drop-down menu and click **Apply**.

## Enabling or disabling the RFTAG option:

This option makes RF Code sensor tags available for the Server Technology wireless monitoring solution.

Click on the **Edit** link in the Action column next to the port to be configured.

On the following Serial Ports Edit page, select **Enabled** or **Disabled** from the RFTAG drop-down menu and click **Apply**.

## Configuring the Bluetooth™ options:

If the PT45 has been equipped for the mobile monitoring solution using Bluetooth® technology, several Bluetooth parameters will be available for editing on the Serial Ports configuration page.

Click the **Edit** link in the Action column to configure the following parameters.

Provide a value as described for each parameter field, and click **Apply**.

### Firmware Bluetooth Parameters

Parameter	Description and Valid Values/Range
Bluetooth Name	Descriptive name of the Bluetooth module that displays in the list of discovered modules on the Android device. The default module name is "ST Eye". The name cannot be blank; Valid range is 1-31 characters.
Bluetooth Discoverability	Settings that determine the current status of the pushbutton on the Bluetooth module. <ul style="list-style-type: none"><li>• Always – The Bluetooth module is discoverable, even without pressing the pushbutton.</li><li>• Limited – (Default). The pushbutton on the Bluetooth module must be pressed to make the module discoverable for 60-seconds.</li><li>• Never – The Bluetooth module is never in discoverable mode.</li></ul>
Bluetooth Pin Code	The pin code is available for legacy Bluetooth modules that require a pin to pair the module. Although not used in current Bluetooth modules, the pin code is supported if needed. Default is 9611; must be 4-digits; range is 0000 to 9999.
Bluetooth Transmission Power	Designated transmission power (dbm) for the Bluetooth module. Note that lowering the transmission power reduces the effective range of the module. Default is 0; range is -6 to 4 dbm.



## **Towers**

The Towers configuration page is used for assignment and/or editing of:

- Descriptive names
- Serial and Model numbers
- Operation voltage types

---

**NOTE:** If set at the factory, you cannot edit the serial number, model number, and voltage type.

---

### **Creating a descriptive tower name:**

In the Tower Name field, enter a descriptive name and click **Apply**.

### **Setting the tower serial number:**

In the Serial Number field, enter the serial number of the unit and click **Apply**.

### **Setting the tower model number:**

In the Model Number field, enter the model number of the unit and click **Apply**.

### **Setting the operational AC or DC voltage type:**

From the AC/DC drop-down menu, select **AC** or **DC**, and click **Apply**.

### **Setting the operational AC voltage type:**

From the 3-Phase drop-down menu, select **yes** or **no**, and click **Apply**.

## **Input Feeds**

The Input Feeds configuration page is used for assignment and/or editing of input feed descriptive names, operational voltage and maximum load capacity.

### **Creating a descriptive input feed name:**

In the Input Feed Name field, enter a descriptive name and click **Apply**.

### **Setting the infeed operational voltage:**

In the Input Feed Voltage field, enter a value from 0 to 480 and click **Apply**.

---

**NOTE:** If Smart Load-Shedding has been activated and UPS voltage polling configured for an infeed, the polled voltage value will be used for all power calculations.

---

### **Setting the infeed maximum load capacity:**

In the Input Feed Load Capacity field, enter a value from 1 to 255 and click **Apply**.

## **UPS**

The UPS Configuration page is used for adding a new UPS device and configuring the UPS devices connected to PT45 units.

---

**NOTE:** The UPS page accepts both IPv4 and IPv6 formats in the Hostname/IP field.

---

### **To add a new UPS:**

Select the UPS manufacturer type from the Type drop-down list, type an IP address (or hostname) for the UPS, and click **Apply**.

### **To edit the UPS type:**

Under the Action heading, click the **Edit** link for the UPS to be configured. The Configuration UPS page reformats to an edit page where UPS device settings are configured and UPS devices are associated with an infeed.

#### *Selecting the UPS type:*

Select the UPS manufacturer type from the UPS Type drop-down list and click **Apply**.

#### *Editing the UPS Hostname/IP Address:*

In the Hostname/IP field, type an IP Address or Hostname and click **Apply**.

### *Editing the UPS SNMP GET community string:*

In the SNMP GET Community String field, type the community string configured on the UPS device and click **Apply**.

### *Enabling/Disabling UPS voltage polling:*

From the Poll UPS Voltage drop-down list, select **Enabled** or **Disabled** and click **Apply**.

### *Editing the UPS SNMP port number:*

In the Port field, type the port number and click **Apply**.

### *Associate the UPS with an infeed:*

Select the infeed(s) powered by the UPS and click **Apply**.

### **To remove a UPS:**

On the Configuration UPS page, under the Action heading, click the **Remove** link for the UPS you want to remove.

## **Outlets**

The Outlets configuration page is used for assignment and/or editing of outlet sequence and reboot timers, descriptive names and wakeup states.

### **Setting the outlet sequencing interval:**

Enter the sequencing interval (in seconds) in the Sequence Interval field and click **Apply**.

### **Setting the outlet reboot delay:**

Enter the reboot interval (in seconds) in the Reboot Delay field and click **Apply**.

### **Editing the outlet descriptive name:**

Click on the **Edit** link in the Action column next to the outlet to be configured.

On the subsequent Outlet Edit page, enter a descriptive name. Up to 24 alphanumeric and other typed characters (ASCII 33 to 126 decimal) are allowed; spaces are not allowed. Click **Apply**.

### **Changing the outlet wakeup state:**

Click on the **Edit** link in the Action column next to the outlet to be configured.

On the subsequent Outlet Edit page, select **On**, **Off** or **Last** from the Wakeup State drop-down menu and click **Apply**.

### **Setting the outlet Post-On delay:**

Click on the **Edit** link in the Action column next to the outlet to be configured.

On the subsequent Outlet Edit page, enter the outlet Post-On delay (in seconds) in the Post-On Delay field and click **Apply**.

## **Groups**

The Groups configuration page is used for creation and deletion of group and assignment of outlets to groups.

### **Creating a group:**

Enter a descriptive group name in the Group Name field. Up to 24 alphanumeric and other typed characters (ASCII 33 to 126 decimal) are allowed; spaces are not allowed. Click **Apply**.

### **Removing a group:**

Click on the **Remove** link in the Action column for the group to be removed and click **Yes** on the subsequent confirmation window.

### **Adding and deleting outlets from a group:**

Click the **Edit** link in the Action column for the associated group.

On the subsequent Group Edit page, select or deselect outlets to be included in that group, and click **Apply**.

## Users

The Users configuration page is used for creation and removal of usernames, assignment of accessible outlets and group, assignment of privilege levels and the changing of user passwords.

### **Creating a new user:**

Enter a user name in the Username field. Up to 16 alphanumeric and other typed characters (ASCII 33 to 126 decimal) are allowed; spaces are not allowed.

Enter a password for the new user and verify in the Password and Verify Password fields. For security, password characters are not displayed. Click **Apply**.

### **Removing a user:**

Click on the **Remove** link in the Action column for the user to be removed and click **Yes** on the subsequent confirmation window.

### **Changing a user password:**

Click on the **Edit** link in the Action column for the associated user.

On the subsequent User Edit page, enter a password and verify the new password for the new user in the Password and Verify Password fields. For security, password characters are not displayed. Click **Apply**.

### **Changing a user's access privilege level:**

The PT45 unit has the following defined privilege levels:

- **Admin:** Full-access for all configuration, control (On, Off, Reboot), status and serial/Pass-Thru ports.
- **Power User:** Full-access for all control (On, Off, Reboot), status and serial/Pass-Thru ports.
- **User:** Partial-access for control (On, Off, Reboot), status and Pass-Thru of assigned outlets, groups and serial/Pass-Thru ports.
- **Reboot-Only:** Partial-access for control (Reboot), status and Pass-Thru of assigned outlets, groups and serial/Pass-Thru ports.
- **On-Only:** Partial-access for control (On), status and Pass-Thru of assigned outlets, groups and serial/Pass-Thru ports.
- **View-Only:** Partial-access for status and Pass-Thru of assigned outlets, groups and serial/Pass-Thru ports.

The administrator may also grant administrative privileges to other user accounts allowing the PT45 to have more than one administrative-level user.

---

**NOTE:** You cannot remove administrative privileges from the **admin** user unless another user has already been given administrative access level privileges created. For security, Server Technology recommends first creating a new administrative user account with administrative rights before removing the default account **admin**.

---

Click on the **Edit** link in the Action column for the associated user.

On the subsequent User Edit page, select **Admin**, **Power-User**, **User**, **Reboot-only**, **On-only** or **View-only** from the Access Level drop-down menu and click **Apply**.

### **Granting or removing Environmental Monitoring viewing privileges:**

Click on the **Edit** link in the Action column for the associated user.

On the subsequent User Edit page, select **Yes** or **No** from the Environmental Monitoring drop-down menu and click **Apply**.

### **Adding and deleting outlet access:**

Click on the **Outlets** link in the Access column for the associated user.

On the subsequent User Outlets page, select or deselect outlets to be accessed by the user and click **Apply**.

### **Adding and deleting group access:**

Click on the **Groups** link in the Access column for the associated user.

On the subsequent User Groups page, select or deselect group to be accessed by the user and click **Apply**.

## **FTP**

The FTP configuration page is used for setup and maintenance of all settings required to perform an FTP firmware upload, configure automatic FTP updates or system configuration uploads/downloads.

---

### **NOTES:**

- The FTP page accepts both IPv4 and IPv6 formats in the Host field.
  - Secure File Transport Protocol (SFTP) is also supported for encrypted SSH transport over the network.
- 

### **Setting the FTP host address:**

Enter the IP address or hostname in the Host field and click **Apply**.

### **Setting the FTP username:**

Enter the FTP server username in the Username field, and click **Apply**.

### **Setting the FTP password:**

Enter the FTP server password in the Password field, and click **Apply**.

### **Setting the filepath:**

Enter the path of the file to be uploaded in the Directory field, and click **Apply**.

### **Setting the filename for upload:**

Enter the filename of the file to be uploaded in the Filename field, and click **Apply**.

### **Testing the FTP upload configuration:**

This test validates that the unit is able to contact and log onto the specified FTP server, download the firmware file and verify that the firmware file is valid for this unit. Click **Test**.

### **Enabling or disabling automatic updates:**

The PT45 features the ability to schedule automatic firmware updates. When enabled and configured, the unit will regularly check the FTP server for a new firmware image and upload it.

Select **Enabled** or **Disabled** from the drop-down menu and click **Apply**.

### **Setting the automatic update scheduled day:**

Select the desired day for the automatic update from the drop-down menu and click **Apply**.

### **Setting the automatic update scheduled hour:**

Select the desired hour for the automatic update from the drop-down menu and click **Apply**.

### **Enabling or disabling the FTP server:**

The PT45 features the ability to upload and download system configuration files to ease implementation across multiple devices. .

Select **Enabled** or **Disabled** from the drop-down menu and click **Apply**

---

**NOTE:** The FTP server must be enabled for configuration upload or download.

---

## **SNTP/Syslog**

The SNTP/Syslog page sets the options for the SNTP server, time zone, Daylight Saving Time (DST) automatic clock adjustment, and Syslog server.

### ***About Daylight Saving Time(DST)***

Support for DST is disabled by default. When enabled, the date and time are automatically adjusted forward one hour between the starting and ending dates and times (which can be configured).

---

**NOTE: If Daylight Saving Time (DST) is enabled, all system time displays will be shown with the current DST start/end date/time settings.**

---

The default time zone is set for the United States until at least 2015.

The time zone format is: **mo.w.d/h:m:s**, as follows:

**mo** = month from January to December (1-12)  
**w** = week number (1-4) or the last week (5)  
**d** = day of week from Sunday to Saturday (0-6)  
**h** = hour (0-23)  
**m** = minute (0-59)  
**s** = second (0-59)

### **Setting the local date/time:**

The Date/Time (Local) field shows the current DST settings. To increment the settings – based on updates to the start/end day/time options – click **Update**.

### **Setting the SNTP primary/secondary server address:**

The Primary/Secondary Host fields contact the SNTP server; the fields are populated with the external NTP pool time zones “2.servertech.pool.ntp.org” and “1.servertech.pool.ntp.org” as default for new PT45s that have not yet been time set.

Enter the IP address or hostname in the Primary Host and/or Secondary Host field and click **Apply**.

### **Setting the Local GMT offset (hours/minutes):**

The GMT offset supports all standard international time zones from -12:59 to +14:59. The GMT offset can be set in minutes to accommodate partial-hour time zones.

Select the local offset from GMT value from the drop-down menu and click **Apply**.

### **Enabling or disabling Daylight Saving Time (DST):**

Select **Enabled** or **Disabled** from the SNMPv3 Agent drop-down menu and click **Apply**.

### **Setting Daylight Saving Time (DST) start/end date/time options:**

Select the week/day/month and hour/minute/second for the start date/time and end date/time from the drop-down menus and click **Apply**.

### **Setting the Syslog server address:**

Enter the IP address or hostname in the Primary and/or Secondary Host field and click **Apply**.

---

**NOTE: Both IPv4 and IPv6 formats are accepted in the Primary/Secondary Host fields.**

---

### **Changing the Syslog server port number:**

In the Syslog Port field, enter the port number and click **Apply**.

## **SNMP/Thresholds**

The SNMP/Thresholds configuration page allows setup and maintenance of all SNMP agent settings required to enable SNMP. The page also provides access to the trap configuration pages for towers, input feed, environmental monitor, and sensors.

---

**NOTE:** Traps are generated according to a hierarchical architecture; for example, if a tower status enters a trap condition, only the tower status trap is generated. Infeed and outlet status traps are suppressed until the tower status returns to normal.

---

### **About SNMP versions:**

The firmware supports SNMP versions 1, 2, and 3.

SNMP version 3 supports authentication and encryption on a per user basis. Authentication types are None and MD5. Encryption types are None and DES. If you use authentication, you must use encryption.

Two SNMPv3 users are supported: one user with read-write (RW) access, and one user with read-only (RO) access. Both users have the same configuration parameters, and you can configure each user independently.

SNMPv2 and SNMPv3 can be enabled or disabled independently. You can have SNMPv2 and/or SNMPv3, or none.

### **Enabling or disabling SNMP v3 support:**

Select **Enabled** or **Disabled** from the SNMPv3 Agent drop-down menu and click **Apply**.

---

**NOTE:** The default for SNMP support is **Enabled**. When Server Technology products are shipped, the default SNMP configuration for the GET community string is set to “**public**” and the SET community string is left **blank**.

---

### **Setting the SNMPv3 read-write (RW) user or read-only (RO) user:**

Enter the Read-Write User or Read-Only User username and click **Apply**. A valid username can be set to any value between 1-31 characters.

### **Configuring the SNMPv3 read-write (RW) user or read-only (RO) user authentication type:**

From the Read-Write User or Read-Only User Authentication Type drop-down menu, select None or MD5, and click **Apply**. To clear the password, check **Change Password**.

### **Setting the SNMPv3 read-write (RW) user or read-only (RO) user authentication password:**

Enter the Read-Write (RW) User or Read-Only (RO) User Password and, and click **Apply**. To clear the password, check **Change Password**. A valid authentication password can be set to any value between 1-39 characters. A blank password will clear the string.

### **Configuring the SNMPv3 read-write (RW) user or read-only (RO) user privacy type:**

From the Read-Write User or Read-Only User Privacy Type drop-down menu, select None or DES, and click **Apply**. To clear the password, check **Change Password**.

### **Setting the SNMPv3 read-write (RW) user or read-only (RO) user privacy password:**

Enter the Read-Write User or Read-Only User privacy password and, and click **Apply**. To clear the password, check **Change Password**. A valid password can be set to any value between 1-31 characters.

### **Setting the SNMPv3 trap username:**

The optional trap username displays on SNMP activity logs to identify user actions.

Type a name in the Trap Username field and click **Apply**. The trap username can be 1-31 alphanumeric characters; spaces are allowed; and the name is case sensitive.

## Configuring general parameters for any SNMP version:

### *Setting trap destinations:*

Type an IP address or hostname as necessary in the trap destination field(s) and click **Apply**.

---

**NOTE:** Both IPv4 and IPv6 formats are accepted in the “Trap Destination 1” and “Trap Destination 2” fields.

---

### *Setting the error trap repeat time:*

Type a time value in the Error Trap Repeat Time field and click **Apply**. The valid range is 1 to 65535 (in seconds).

### *Setting IP restrictions:*

From the IP Restrictions drop-down menu, select the No Restrictions or Trap Destinations Only option and click **Apply**.

---

**NOTE:** When the Trap Destinations Only option is selected, SNMP Manager Get and Set requests are allowed only from the IP address of the defined trap destinations.

---

### *Setting the SNMP SysName, SysLocation or SysContact objects:*

In the appropriate field, enter the SysName, SysLocation or SysContact objects and click **Apply**.

### *Enabling or disabling tower traps:*

Click on the **Tower Traps** link.

On the subsequent Tower Traps page, select or deselect the desired traps and click **Apply**.

### *Configuring input feed traps and thresholds:*

Click on the **Input Feed Traps and Thresholds** link.

On the subsequent Input Feed Traps page, select or deselect the desired traps and click **Apply**.

For Load traps, enter a maximum load value for the infeed in the High Load Threshold field and click **Apply**. The default input feed high load threshold is 80% of the input feed maximum load capacity.

### *Configuring outlet traps:*

Click on the **Outlet Traps and Thresholds** link.

On the subsequent Outlet Traps and Thresholds page, select or deselect the desired traps and click **Apply**.

### *Enabling or disabling Environmental Monitor traps:*

Click on the **Environmental Monitor Traps** link.

On the subsequent page, select or deselect the desired traps and click **Apply**.

### *Configuring Temperature and Relative Humidity sensor traps:*

Click the **Sensor Traps and Thresholds** link.

On the subsequent Sensor Traps and Thresholds page, select or deselect the desired trap checkboxes and click **Apply**.

### *Configuring Temperature and Relative Humidity sensor thresholds:*

Click the **Sensor Traps and Thresholds** link.

For temperature thresholds, type a low and high temperature value in the Low Temp and High temp fields and click **Apply**.

For relative humidity thresholds, type a low and high humidity percentage in the Low Humid and High Humid fields, and click **Apply**.

---

**NOTE:** For temperature thresholds, the valid range is 0 to 123 in degrees Celsius or 32 to 254 in degrees Fahrenheit. For relative humidity, the valid range is 0 to 100 (in percentage of relative humidity).

---

### *Configuring Temperature and Humidity Recovery Delta (Hysteresis):*

Click the **Sensor Traps and Thresholds** link.

The Recovery Delta field allows configuration of the number of degrees of change needed to recover from a temperature alarm. After exceeding the high-temperature threshold, the temperature value must fall below the high-temperature threshold by the number of degrees specified in the Recovery Delta field before the sensor recovers.

For example, if the High Temp value is 80 degrees Fahrenheit, and the Recovery Delta field is 2 degrees Fahrenheit, the sensor will not recover until a temperature value of 78 degrees Fahrenheit is reported.

To configure a temperature recovery delta (hysteresis), in the Recovery Delta field for “Temp”, type a value (in degrees) and click **Apply**. Valid range is 0-30 Celsius or 0-54 Fahrenheit.

To configure a humidity recovery delta (hysteresis), in the Recovery Delta field for “Humid”, type a value (in percent) and click **Apply**. Valid range is 0-20%.

---

**NOTE:** The default value for the Recovery Delta field is 1 degree Celsius and 2 degrees Fahrenheit.

---

## **LDAP**

The LDAP configuration page is used for setup and maintenance of all settings required to enable LDAP support. For more information and the configuration requirements, see the “LDAP” section.

### **Enabling or disabling LDAP support:**

Select **Enabled** or **Disabled** from the LDAP drop-down menu and click **Apply**.

### **Configuring the authentication order:**

Select **Remote** -> **Local** or **Remote Only** from the drop-down menu and click **Apply**.

---

**NOTE:** Server Technology recommends not setting the authentication order to Remote Only until LDAP has been configured and tested.

---

### **Setting the LDAP server address:**

Enter the IP address or hostname in the Primary and/or Secondary Host field and click **Apply**.

---

**NOTE:** Both IPv4 and IPv6 formats are accepted in the Primary/Secondary Host fields.

---

### **Changing the LDAP server port:**

Enter the port number in the LDAP Port field and click **Apply**.

### **Setting the LDAP bind type:**

The PT45 supports three standard LDAP bind methods:

**Simple:** Uses unencrypted delivery of username-password over the network to the LDAP server for authentication, showing user credentials in plain text.

**TLS/SSL:** (LDAP over TLS/SSL) Uses a trusted authority certificate to provide encryption of LDAP authentication.

**MD5:** Provides strong protection using 1-way hash encoding that does not transmit the username-password over the network.

From the Bind Type drop-down menu, select Simple, TLS/SSL, or MD5, and click **Apply**.

---

**NOTE:** If LDAP over TLS/SSL is enabled, MD5 binding is disabled.

---

### **Setting the search bind Distinguished Name (DN):**

Enter the distinguished name (DN) in the Search Bind field and click **Apply**.

### **Setting the search bind password for Distinguished Name (DN):**

Enter the Search Bind Password in the Search Bind Password field and click **Apply**.

### **Setting the user search base Distinguished Name (DN):**

Enter the User Search Base DN in the User Search Base DN field and click **Apply**.

### **Setting the user search filter:**

Enter the User Search Filter in the User Search Filter field and click **Apply**.

### **Setting the group membership attribute:**

Enter the group membership attribute in the Group Membership Attribute field and click **Apply**.

### **Enabling or disabling group search:**

Select **Enabled** or **Disabled** from the Group Search drop-down menu and click **Apply**.

### **Setting the group search base Distinguished Name (DN):**

The Group Search Base DN indicates where the LDAP group search will start.

Enter the Base DN in the Group Search Base DN field and click **Apply**.



## Setting the user membership attribute name:

The User Membership Attribute is a comma-delimited string of up to two attribute names whose values in the search results are the users that are members of the group. Maximum numbers of characters is 61.

Enter the user membership attribute name(s) in the User Membership Attribute field and click **Apply**.

---

**NOTE:** The user membership option allows the searching of directory entries of groups for a user membership attribute to find the groups for which the user is a member.

---

## Setting the DNS IP address:

For information about how to set the DNS IP address, see the “Network” section.

## Configuring LDAP groups:

Click on the **LDAP Groups** link at the bottom of the page.

### *Creating an LDAP group:*

Enter a descriptive group name in the LDAP Group Name field. Up to 24 alphanumeric and other typed characters (ASCII 33 to 126 decimal) are allowed; spaces are not allowed. Press **Apply**.

### *Removing an LDAP group:*

Click on the **Remove** link in the Action column for the group to be removed and click **OK** on the subsequent confirmation window.

### *Changing an LDAP group’s access privilege level:*

Click on the **Edit** link in the Action column for the associated LDAP Group.

On the subsequent LDAP Group - Edit page, select **Admin**, **User**, **On-only** or **View-only** from the Access Level drop-down menu and click **Apply**.

For more information about access privilege levels, see the “Changing a user’s access privilege level” section.

### *Granting or removing environmental monitoring viewing privileges:*

Click on the **Edit** link in the Action column for the associated LDAP Group.

On the subsequent LDAP Group - Edit page, select **Yes** or **No** from the Environmental Monitoring drop-down menu and click **Apply**.

---

**NOTE:** Granting access to environmental monitoring (temperature/humidity/sensors) to a non-admin user also grants that user access to power monitoring (outlets, infeeds, towers – all the environmental data of the unit).

---

### *Adding and deleting outlet access:*

Click on the **Outlets** link in the Access column for the associated LDAP Group.

On the subsequent LDAP Group - Outlets page, select or deselect outlets to be accessed by the LDAP Group and click **Apply**.

### *Adding and deleting outlet group access:*

Click on the **Groups** link in the Access column for the associated LDAP Group.

On the subsequent LDAP Group - Groups page, select or deselect outlet groups to be accessed by the LDAP Group and click **Apply**.

### *Adding and deleting serial port access:*

Click on the **Ports** link in the Access column for the associated LDAP Group.

On the subsequent LDAP Group - Ports page, select or deselect ports to be accessed by the LDAP Group and click **Apply**.

## **TACACS+**

The TACACS+ configuration page is used for setup and maintenance of all settings required to enable TACACS+ support.

### **Enabling or disabling TACACS+ support:**

Select **Enabled** or **Disabled** from the TACACS+ drop-down menu and click **Apply**.

### **Changing the TACACS+ server port:**

Enter the port number in the Port field and click **Apply**.

### **Setting the TACACS+ server address:**

Enter the IP address or hostname in the Primary and/or Secondary Host field and click **Apply**.

---

**NOTE:** Both IPv4 and IPv6 formats are accepted in the Primary/Secondary Host fields.

---

### **Configuring the authentication order:**

Select **Remote > Local** or **Remote Only** from the drop-down menu and click **Apply**.

---

**NOTE:** Server Technology recommends not setting the authentication order to Remote Only until TACACS has been configured and tested.

---

### **Setting the TACACS+ encryption key:**

Enter a key and verify the new key the Encryption Key and Verify Encryption Key fields. Click **Apply**.

For security, key characters are not displayed.

### **Configuring TACACS+ privilege levels:**

Click on the **TACACS+ Privilege Levels** link at the bottom of the page.

#### ***Changing an TACACS+ Privilege Level's access privilege level:***

Click on the **Edit** link in the Action column for the associated TACACS+ Privilege Level.

On the subsequent TACACS+ Privilege Level - Edit page, select **Admin**, **User**, **On-only** or **View-only** from the Access Level drop-down menu and click **Apply**.

#### ***Granting or removing Environmental Monitoring viewing privileges:***

Click on the **Edit** link in the Action column for the associated TACACS+ privilege level.

On the subsequent TACACS+ Privilege Level - Edit page, select **Yes** or **No** from the Environmental Monitoring drop-down menu and click **Apply**.

#### ***Adding and Deleting outlet access:***

Click on the **Outlets** link in the Access column for the associated TACACS+ Privilege Level.

On the subsequent LDAP Group - Outlets page, select or deselect outlets to be accessed by the TACACS+ Privilege Level and click **Apply**.

#### ***Adding and Deleting outlet group access:***

Click on the **Groups** link in the Access column for the associated TACACS+ Privilege Level.

On the subsequent LDAP Group - Groups page, select or deselect outlet groups to be accessed by the TACACS+ Privilege Level and click **Apply**.

#### ***Adding and Deleting serial port access:***

Click on the **Ports** link in the Access column for the associated TACACS+ Privilege Level.

On the subsequent LDAP Group - Ports page, select or deselect ports to be accessed by the TACACS+ Privilege Level and click **Apply**.

## **RADIUS**

The Remote Authentication Dial-in User Service (RADIUS) configuration page is used for setup and maintenance of all settings required to enable RADIUS support.

The Remote Authentication Dial-in User Service (RADIUS) configuration page is used for setup and maintenance of all settings required to enable RADIUS support.

### **Enabling or disabling RADIUS support:**

Select Enabled or Disabled from the RADIUS drop-down menu and click **Apply**.

### **Configuring the authentication order:**

Select **Remote > Local** or **Remote Only** from the drop-down menu and click **Apply**.

---

**NOTE:** Server Technology recommends not setting the authentication order to Remote Only until RADIUS has been configured and tested.

---

### **Changing the RADIUS server address:**

Enter the IP address or hostname in the Primary and/or Secondary Server field and click **Apply**.

---

**NOTE:** Both IPv4 and IPv6 formats are accepted in the Primary/Secondary Host fields.

---

### **Setting the RADIUS shared secret:**

The shared secret is the RADIUS authentication key.

Enter the shared secret in the Primary and Secondary Shared Secret field. Up to 48 upper and lowercase alphanumeric and other typed characters (ASCII 33 to 126 decimal) and spaces are allowed; control characters are not allowed. Click **Apply**.

To change the shared secret, check the Change checkbox to clear the Shared Secret field, enter the new shared secret, and click **Apply**.

### **Changing the RADIUS server port:**

This field specifies the port number used by the RADIUS server for incoming RADIUS authentication requests.

Enter the port number in the Primary and/or Secondary Port field and click **Apply**.

The valid port number range is 1-65535; default is 1812.

### **Setting the RADIUS server timeout value:**

The Timeout field specifies the time interval (in seconds) to wait for a reply from the RADIUS server before resending an authentication request.

Enter the timeout value (in seconds) in the Primary and/or Secondary Timeout field and click **Apply**.

The valid timeout range is 1-30 seconds; default is 5 seconds.

### **Setting the number of RADIUS server retries:**

The Set RADIUS Retries command specifies the number of times an authentication request is sent to the RADIUS server. The PT45 will attempt authentication with the primary server until the number of retries is reached, then will attempt authentication with the secondary server. If the unit does not receive a response from these attempts, the authentication request will be rejected.

#### ***Setting the number of retries:***

At the Switched CDU: prompt, type **set radius**, followed by **primary** or **secondary**, followed by **retries**, and followed by the number of retries (0-10). Click **Enter**.

#### ***Examples***

The following command sets the retries for the primary RADIUS server to 5:

```
Switched CDU: set radius primary retries 5<Enter>
```

The following command sets the retries for the secondary RADIUS server to 2:

```
Switched CDU: set radius secondary retries 2<Enter>
```

## **SMTP/Email**

The SMTP/Email page allows the configuration of Simple Mail Transfer Protocol (SMTP) and Email options.

### **Enabling or disabling Email support:**

Select **Enabled** or **Disabled** from the Email Notifications drop-down menu and click **Apply**.

### **Setting the SMTP server address:**

Enter the IP address or hostname in the SMTP Host field and click **Apply**.

---

**NOTE:** Both IPv4 and IPv6 formats are accepted in the Host field.

---

### **Changing the SMTP server port:**

Enter the port number in the SMTP Port field and click **Apply**.

### **Setting the SMTP authentication type:**

---

#### **NOTES:**

- SMTP authentication allows the mail client in the PT45 to login to the mail server during the process of sending a mail. The mail server may require this login to relay mail to another mail server.
  - Supported SMTP authentication types are: None (default, no SMTP authentication); Digest-MD5; CRAM-MD5; Login; and Plain. SMTP authentication occurs with a configured username and password, or you can use the address in the From Address field in place of the username.
- 

From the SMTP Authentication drop-down menu, select an authentication method. From the “with” drop-down menu, select “SMTP Username” or “From Address”. Click **Apply**.

### **Setting the Email SMTP authentication username:**

In the Username field, type the desired Email SMTP username and click **Apply**. Spaces are not allowed.

### **Setting the Email SMTP authentication password:**

The Set Email SMTP Password command sets the password for SMTP authentication with the username.

In the Password field, type a password of 1-16 alphanumeric and other characters (ASCII 33 to 126 decimal) are allowed; passwords are case sensitive. Click **Apply**.

To change the password, type over it, check the Change checkbox, and click **Apply**.

### **Setting the ‘From’ email address:**

Enter the ‘from’ email address in the ‘From’ Address field and click **Apply**.

### **Setting the ‘Send To’ email address:**

Enter the ‘send to’ email address in the Primary or Secondary ‘Send To’ Address field and click **Apply**.

If the primary ‘send to’ address fails, the system then attempts to send the email to the secondary ‘send to’ address.

### **Setting the subject ID:**

From the Subject ID drop-down menu, select the default “Sentry3\_524640” option or the “Location” option to specify the email subject line. Click **Apply**.

### **Enabling or disabling event type notifications:**

Check the type of event message to enable, and click **Apply**. Options are Event Messages, Authentication Messages, power Messages, and Configuration Messages.

### **Sending a test email:**

After providing information in the Email/SMTP web page, click the **Test** button to send a test email to the target email destinations.

## **Features**

The Features configuration page is used for activation and maintenance of special features purchased from Server Technology. From this page an administrator can review all activated features as well as activate newly purchased features.

### **To activate a special feature:**

In the Feature Key Value field, enter the activation key provided by Server Technology and click **Apply**.

---

**NOTE:** A restart of the PT45 is required after activating new special features.

---

## **Tools**

The Tools section contains access to rebooting the unit, uploading new firmware as well as resetting the unit to factory defaults. This section is available to administrative level users only.

## **Ping**

You can use the Ping feature to test the ability of the PT45 to contact the IP address of another Ethernet-enabled device. For LDAP support, it can also be used to test the configuration of the Domain Name server IP address by testing for proper name resolution.

---

**NOTE:** Both IPv4 and IPv6 formats are accepted in the Ping Host Name/IP Address field.

---

## **Change Password**

The Change Password feature allows users to change their own password.

---

**NOTE:** A new password can always be assigned by the administrator.

---

### **Changing a password:**

Enter the current password, enter a new password and verify the new password. Click **Apply**.

## **Firmware**

The Firmware page allows the uploading of a system firmware (.bin) file. Click Browse to locate the .bin firmware file, and then click Upload. A confirmation message is displayed.

## **View Log**

The View Log feature enables viewing of the internal system log. This feature logs all authentication attempts, power actions, configuration changes and other system events. The system memory stores more than 4000 entries in a continuously aging log. For permanent off-system log storage, the Syslog protocol is supported. .

---

**NOTE:** Only system administrators can view the system log.

---

### **Reviewing the system log:**

Click on the **Previous 100 entries** or **Next 100 entries** link to navigate through the log.

## **Restart**

### **Performing a warm boot:**

Select the **Restart** from the Action drop-down menu and click **Apply**.

---

**NOTE:** System user/outlet/group configuration or outlet states are not changed or reset with this command.

---

### **Resetting to factory defaults:**

For more information about resetting a PT45 to factory defaults from the Web interface, see Appendix A.

### **Uploading new firmware:**

For more information about uploading new firmware from the Web interface, see Appendix B.

### **Generating a new SSL X.509 certificate:**

Select the **Restart and generate a new X.509 certificate** from the Action drop-down menu and click **Apply**.

### **Computing new SSH security keys:**

Select the **Restart and compute new SSH keys** from the Action drop-down menu and click **Apply**.

## Command Line Interface

**IMPORTANT:** The Command Line Interface (CLI) was modified to allow both IPv4 and IPv6 settings.

### Logging In

Logging in through Telnet requires directing the Telnet client to the configured IP address of the unit.

Logging in through the Console (RS232) port requires the use of a terminal or terminal emulation software configured to support ANSI or VT100 and a supported data rate (300, 1200, 2400, 4800, 9600, 19200, 38400, 57600, or 115200 BPS) - 8 data bits-no parity-one stop bit and Device Ready output signal (DTR or DSR). The default data rate is 9600.

#### To log in by RS-232 or Telnet:

1. Press **Enter**. The following appears, where **x.xx** is the firmware version:

```
Sentry Switched CDU Version x.xx  
Switched CDU:
```

**NOTE:** Logging in by Telnet will automatically open a session. It is not necessary to press Enter.

2. At the Username: and Password: prompts, enter a valid username and password. And press **Enter**.

You are given three attempts to enter a valid username and password combination. If all three fail, the session ends.

**NOTE:** The default username/password is **admin/admin**.

When you enter a valid username and password, the command prompt (Switched CDU:) appears. If a location identifier was defined, it will be displayed before the Switched CDU: prompt.

You can enter commands in any combination of uppercase and lowercase. All command characters must be entered correctly; there are no command abbreviations. A user must have administrative privileges to use the administration commands. The following tables list and briefly describe each command.

### Operations Command Summary

Command	Description
Connect	Connects to a serial/Pass-Thru port
Envmon	Displays the status of the integrated Environmental Monitor
IStat	Displays the status of the infeeds
List Group	Lists all assigned outlets for a group name
List Groups	Lists all accessible groups for the current user
List Outlets	Lists all accessible outlets for the current user
List Ports	Lists all accessible serial/Pass-Thru ports for the current user
Login	Ends the current session and brings up the Username: prompt
Logout	Ends a session
Off	Turns one or more outlets off
On	Turns one or more outlets on
Password	Changes the password for the current user
Quit	Ends a session
Reboot	Reboots one or more outlets
Status	Displays the on/off status of one or more outlets
UPSSStat	Displays the status of the associated UPSs
Add Grouptouser	Grants a user access to one or more groups
Add Outlettogroup	Adds an outlet to a group name
Add Outlettouser	Grants a user access to one or all outlets
Add Porttouser	Grants a user access to one or all serial/Pass-Thru ports
Create Group	Adds a group name
Create UPS	Adds a UPS association

## Administrative Command Summary

---

Create User	Adds a user account
Delete Groupfromuser	Removes access to one or more groups for a user
Delete Outletfromgroup	Deletes an outlet from a group name
Delete Outletfromuser	Removes access to one or all outlets for a user
Delete Portfromuser	Removes access to one or all serial/Pass-Thru ports
List User	Displays all accessible outlets/groups/ports for a user
List Users	Displays privilege levels for all users
Remove Group	Deletes a group name
Remove UPS	Deletes a UPS association
Remove User	Deletes a user account
Restart	Performs a warm boot
Set Banner	Set the pre-login banner text
Set DHCP	Enables or disables DHCP support
Set DHCP Boot Delay	Enables/disables a 90-second boot delay between PT45 and DHCP server
Set DHCP Static Address Fallback	Enables or disables DHCP fallback to a static IP address
Set DNS	Sets the IP address of the Domain Name server
Set EnergyWise	Enables or disables the Cisco EnergyWise network
Set EnergyWise Domain	Sets the Cisco EnergyWise domain name
Set EnergyWise Port	Sets the Cisco EnergyWise port number
Set EnergyWise Secret	Sets the Cisco EnergyWise secret
Set Envmon Name	Specifies a descriptive field fro the integrated Environmental Monitor
Set Envmon THS Name	Specifies a descriptive field for a temperature-humidity sensor
Set FTP Autoupdate Day	Sets the automatic FTP update day
Set FTP Autoupdate Hour	Sets the automatic FTP update hour
Set FTP Autoupdate	Enables or disables automatic FTP update support
Set FTP Directory	Specifies the directory for the file to be uploaded
Set FTP Filename	Specifies the file to be uploaded via FTP
Set FTP Host	Sets the FTP Host IP address or hostname
Set FTP Password	Sets the password for the FTP Host
Set FTP Test	Validates PT45 can login to FTP server and verify/download firmware file
Set FTP Server	Enables or disables the FTP server
Set FTP Username	Sets the username for the FTP Host
Set Gateway	Sets the gateway of the PT45
Set HTTP	Enables or disables HTTP access and sets the HTTP target port.
Set HTTP Port	Specifies the target port for HTTP access
Set Infeed Loadmax	Specifies the maximum load capacity for the infeed
Set Infeed Name	Specifies a descriptive field for the infeed
Set Infeed Voltage	Specifies the nominal input voltage for the infeed
Set Ipaddress	Sets the IP address of the PT45
Set LDAP UseTLS	Enables or disables LDAP over TLS/SSL support
Set Location	Specifies a descriptive field for the Web control screen and login banner
Set Net	Determines acquisition method for protocol stack and IPv4/IPv6 addresses
Set Option Button	Enables or disables the external configuration reset button
Set Option Coldboot Alert	Enables or disables the Coldboot Alert feature using a serial protocol
Set Option More	Enables or disables the More prompt
Set Option More	Enables or disables the 'more' prompt



## Administrative Command Summary (continued...)

Set Option Outlet Sequence	Configures outlet power-on sequence order as normal or reversed
Set Option StrongPasswords	Enables or disables strong password requirements
Set Option Tempscale	Sets the Environmental Monitor temperature scale
Set Option CLI Timeout	Sets the Command Line Interface (CLI) session timeout period
Set SNMP IP Restrict	Allows SNMP Get and Set requests only from defined trap destinations
Set Option Prompt	Configures a custom CLI prompt
Set Option Web Timeout	Sets the web session (Web Interface) timeout period
Set Outlet Name	Specifies a descriptive field for a device attached to an outlet
Set Outlet PostOnDelay	Sets the Post-On delay for an outlet
Set Outlet RebootDelay	Sets the reboot delay for all outlets
Set Outlet SeqInterval	Sets the sequencing interval for all outlets
Set Outlet Wakeup	Sets the wakeup state for an outlet
Set Port DSR Check	Sets the DSR active signal checking for a serial/Pass-Thru port
Set Port Name	Specifies a descriptive field for a serial/Pass-Thru port
Set Port Speed	Set the connection speed for all serial/Pass-Thru ports
Set Port Timeout	Sets the inactivity timer for Pass-Thru sessions
Set SNTP	Sets the IP address or hostname of the SNTP servers
Set SNTP DST	Enables or disables Daylight Saving Time (DST)
Set SNTP DST End	Specifies the settings for DST day/time end parameters
Set SNTP DST Start	Specifies the settings for DST day/time start parameters
Set SNTP GMTOffset	Sets the local GMT offset applied to the SNTP date/time
Set Subnet	Sets the subnet mask of the unit
Set Subnet	Sets the subnet mask of the PT45
Set System Area	Specifies to total system area for the system
Set System Area Unit	Specifies the system area (footprint) unit of measure
Set System Balance	Sets the percentage load out-of-balance threshold for 3-phase systems
Set System PF	Sets the power factor used in the total system power calculation
Set Telnet Port	Sets the Telnet server port number
Set Telnet	Enables or disables Telnet access
Set Tower 3Phase	Specifies the AC voltage type for the tower
Set Tower Model	Specifies the model number for the tower
Set Tower Name	Specifies a descriptive field for the tower
Set Tower ProdSN	Specifies the serial number for the tower
Set Tower	Specifies the AC or DC voltage type for the tower
Set UPS AddInfeed	Adds an infeed association to a UPS
Set UPS DelInfeed	Deletes an infeed association from a UPS
Set UPS GETComm	Sets the UPS 'get' community string
Set UPS Host	Sets the UPS Host IP address or hostname
Set UPS Port	Specifies the target port for a UPS
Set UPS Type	Sets the UPS type
Set UPS VPoll	Enables or disables UPS voltage polling
Show EnergyWise	Displays Cisco EnergyWise network configuration information
Set User Access	Sets the access level for a user
Set User Envmon	Grants or removes privileges to view input/environmental monitoring status
Set User Password	Changes the password for a user
Show FTP	Displays FTP configuration information
Show Infeeds	Displays infeed configuration information

## Administrative Command Summary (continued...)

Show Network	Displays network configuration information for all IPv4 and IPv6 settings
Show Options	Displays system option information
Show Outlets	Displays configuration information for all outlets
Show Ports	Displays serial/Pass-Thru port configuration information
Show SNTP	Displays SNTP configuration information
Show System	Displays system configuration information
Show Towers	Displays tower configuration information
Show UPS	Displays UPS configuration information
System Status	Displays system status configuration information
Version	Displays the firmware version

### **To display the names of commands that you can execute:**

At the command prompt, press **Enter**. A list of valid commands for the current user displays.

### **Operations Commands**

Operations commands manage outlet states, provide information about the PT45 environment and control session operations.

#### **Turning outlets on:**

The On command turns on one or more outlets. When the command completes, a display indicating all outlets affected and their current states will be displayed.

##### ***To turn outlets on:***

At the Switched CDU: prompt, type **on**, followed by an outlet name, and press **Enter**, or:

Type **on**, followed by a group name, and press **Enter**, or:

Type **on all** and press **Enter**.

##### ***Examples***

The following command turns the second outlet on, using the outlet's absolute name:

```
Switched CDU: on .B1<Enter>
```

The following command turns on all the outlets in the group named ServerGroup\_1:

```
Switched CDU: on ServerGroup_1<Enter>
```

#### **Turning outlets off:**

The Off command turns off one or more outlets. When the command completes, a display indicating all outlets affected and their current states will be displayed.

##### ***To turn outlets off:***

At the Switched CDU: prompt, type **off**, followed by an outlet name, and press **Enter**, or

Type **off**, followed by a group name, and press **Enter**, or

Type **off all** and press **Enter**

##### ***Examples***

The following command turns off the outlet named FileServer\_1:

```
Switched CDU: off FileServer_1<Enter>
```

The following command turns off all outlets:

```
Switched CDU: off all<Enter>
```

## Rebooting outlets:

The Reboot command reboots one or more outlets. This operation turns the outlet(s) off, delays for a user configurable period and then turns the outlet(s) on. When the command completes, a display indicating all outlets affected and their current states will be displayed.

---

**NOTE:** You will need to re-issue the Status command to verify that the outlets have rebooted.

---

### *To reboot one or more outlets:*

At the Switched CDU: prompt, type **reboot**, followed by an outlet name, and press **Enter**, or

Type **reboot**, followed by a group name, and press **Enter**, or

Type **reboot all** and press **Enter**.

### **Example**

The following command reboots all the outlets in the group named ServerGroup\_1:

```
Switched CDU: reboot ServerGroup_1<Enter>
```

## Displaying outlet status:

The Status command displays the on/off status of one or more outlets. The command displays the status of only those outlets for which the current username has power control access.

This display includes the outlet absolute and descriptive names, the Outlet State reported to the unit by the outlet and the current control state being applied by the PT45. If you do not specify any parameter with this command, the status of all accessible outlets is displayed.

---

**NOTE:** If the user has access to more than 16 total outlets, the Status command will display the first 16 outlets with a prompt to view the remaining outlets.

---

### *To display on/off status of one or more outlets:*

At the Switched CDU: prompt, type **status**, followed by an outlet name, and press **Enter**, or

Type **status**, followed by a group name, and press **Enter**, or

Type **status** and press **Enter**.

### **Examples**

The following command displays the on/off status of the outlet named FileServer\_1:

```
Switched CDU: status FileServer_1<Enter>
      Outlet  Outlet                Outlet  Control
      ID      Name                    State   State
      .A3     FileServer_1             On      On
```

The following command displays the on/off status of all accessible outlets:

```
Switched CDU: status<Enter>
      Outlet  Outlet                Outlet  Control
      ID      Name                    State   State
      .A1     DataServer_1             On      On
      .A2     WebServer_1              On      On
      .A3     FileServer_1             On      On
      .A4     TowerA_Outlet4         On      On
      .A5     TowerA_Outlet5         On      On
      .A6     TowerA_Outlet6         On      On
```

The following command displays the on/off status for outlets in the group ServerGroup\_1:

```
Switched CDU: status ServerGroup_1<Enter>
Group: ServerGroup_1
      Outlet  Outlet                Outlet  Control
      ID      Name                    State   State
      .A1     DataServer_1             On      On
      .A2     WebServer_1              On      On
      .A3     FileServer_1             On      On
```

## Displaying accessible outlets:

The List Outlets command displays accessible outlets for the current user. The display includes the absolute and descriptive name of all outlets assigned to the current user.

### *To display accessible outlets:*

At the Switched CDU: prompt, type **list outlets** and press **Enter**.

### **Example**

The follow command displays all accessible outlets for the current user:

```
Switched CDU: list outlets<Enter>
Outlet  Outlet
ID      Name
.A1     DataServer_1
.B1     WebServer_1
```

## Displaying accessible groups:

The List Groups command displays accessible groups for the current user.

### *To display accessible groups:*

At the Switched CDU: prompt, type **list groups** and press **Enter**.

### **Example**

The follow command displays all accessible groups for the current user:

```
Switched CDU: list groups<Enter>
Groups:
  ServerGroup_1
  RouterGroup_1
```

## Displaying outlets assigned to a group:

The List Group command displays outlets assigned to the specified group name.

### *To display outlets assigned to a group:*

At the Switched CDU: prompt, type **list group**, followed by the group name and press **Enter**.

### **Example**

The follow command displays the outlets assigned to the group ServerGroup\_1:

```
Switched CDU: list group ServerGroup_1<Enter>
Group: ServerGroup_1
Outlet  Outlet
ID      Name
.A1     DataServer_1
.B1     WebServer_1
.C1     FileServer_1
```

## Displaying accessible serial ports:

The List Ports command displays accessible serial ports for the current user.

### *To display accessible serial/Pass-Thru ports:*

At the Switched CDU: prompt, type **list ports** and press **Enter**.

### **Example**

The follow command displays all accessible serial ports for the current user:

```
Switched CDU: list ports<Enter>
Port    Port
ID      Name
Console Console
```

## Displaying infeed status:

The Istat command displays the status of one or more infeeds.

This display includes the infeed absolute and descriptive names and the input status and current load reported to the PT45 by the infeed, branch, or phase.

### *To display status of one or more infeeds:*

Type **istat** and press **Enter**.

### **Examples**

The following command displays the infeed status:

```
Switched CDU: istat

Input      Input      Input      Input
Feed ID    Feed Name   Status     Load
-----
.AA        HQ_1_Infeed_A  On         10.5 Amps
```

## Connecting to a serial device:

The Connect command allows Pass-Thru serial connection to devices attached to the standard serial port (Console).

### *To connect to a serial device:*

At the Switched CDU: prompt, type **connect console** and press **Enter**.

### *To disconnect from a serial device:*

Type **!\*break** and press **Enter**.

## Displaying the status of the Environmental Monitor

The Envmon command displays the status of the integrated Environmental Monitor.

By default, only administrative user accounts are allowed access to the Envmon command. An administrator user can issue the Set User Envmon command to enable and disable access for other user accounts.

### *To display the status of the Environmental Monitor:*

At the Switched CDU: prompt, type **envmon** and press **Enter**.

### **Example**

The following command displays the status of the Environmental Monitor.

```
Switched CDU: envmon<Enter>
Environmental Monitor .A
Name: Florida_HQ_1           Status: Normal
Temperature/Humidity Sensors
ID   Name                      Temperature  Humidity
.A1  Temp_Humid_Sensor_A1       Not Found   Not Found
.A2  T/H2_Florida_HQ_1          23.5 Deg. C  22 % RH
```

## Changing a password:

The Password command changes the current user's password. For security, when you type a password, the characters are not displayed on the screen.

### *To change a password:*

At the Switched CDU: prompt, type **password** and press **Enter**.

At the Enter Current Password: prompt, type the current password and press **Enter**.

At the Enter New Password: prompt, type the new password and press **Enter**. Valid passwords are 1-16 characters.

At the Verify Password: prompt, retype the new password and press **Enter**.

## Starting a new session:

The Login command activates the Username: prompt. The current session ends, allowing a user to log in and start a new session under a different username.

### *To start a new session:*

At the Switched CDU: prompt, type **login** and press **Enter**. The Username: prompt appears.

## Ending a session:

The Quit or Logout commands ends a session. A session ends automatically when no activity is detected for five minutes, or upon loss of connection.

### *To end a session:*

At the Switched CDU: prompt, type **quit** and press **Enter**, or

Type **logout** and press **Enter**.

## Displaying UPS status:

The UPSStat command displays the status of one or more UPS devices associated with the unit. The display includes UPS index number, type, line/battery status, and reported voltage.

---

**NOTE:** Access to this command requires enabling user privileges for environmental monitoring using the Set User Envmon command.

---

### *To display status of one or more UPS devices:*

At the Switched CDU: prompt, type **upsstat** and press **Enter**.

### **Example**

The following command displays the UPS status:

```
Switched CDU: upsstat<Enter>
  UPS      UPS      UPS      UPS
  Index    Type          Status    Voltage
  1        Generic (RFC1628) N/A       N/A
  2        Liebert      On Battery 120.0
  3        MGE        On Utility 119.9
```

## Administration Commands

Administration commands can only be issued by a user with administrative privileges, such as the predefined Admn user or another user who has been granted administrative privileges with the Set User Admnpriv command.

### User Administration

#### **Creating a user account:**

The Create User command creates a user account with the specified username and password.

##### *To create a user account:*

At the Switched CDU: prompt, type **create user**, optionally followed by a 1-16 character username (Spaces are not allowed, and usernames are not case sensitive). Press **Enter**.

At the Password: prompt, type a password of 1-16 alphanumeric and other typed characters - (ASCII 33 to 126 decimal) are allowed; passwords are case sensitive. Press **Enter**.

At the Verify Password: prompt, retype the password. Press **Enter**.

##### **Example**

The following command creates the user account JaneDoe:

```
Switched CDU: create user JaneDoe<Enter>
Password: <Enter>
Verify New Password: <Enter>
```

For security, password characters are not displayed.

#### **Removing a user account:**

The Remove User command removes a user account.

---

**NOTE:** You can remove the predefined user account **adm**n only if another user account has been granted administrative privileges using the Set User Admnpriv command. For security, Server Technology recommends first creating a new administrative user account with administrative rights before removing the default account **adm**n.

---

##### *To remove a user account:*

At the Switched CDU: prompt, type **remove user**, optionally followed by a username. Press **Enter**.

#### **Changing a password:**

The Set User Password command changes a user's password. For security, when you type a password, the characters are not displayed on the screen.

##### *To change a password:*

At the Switched CDU: prompt, type **set user password**, followed by a username and press **Enter**.

At the Password: prompt, type the new password and press **Enter**. Passwords can contain 1-16 characters.

At the Verify Password: prompt, retype the new password and press **Enter**.

##### **Example**

The following command changes the password for the user JohnDoe:

```
Switched CDU: set user password johndoe<Enter>
Password: <Enter>
Verify Password: <Enter>
```

For security, password characters are not displayed.

## Setting user access level privileges:

The Set User Access command sets the access level privileges for a user. The PT45 has the following defined access privilege levels; Admin, Power User, User, Reboot-Only, On-Only and View-Only.

The administrator can also grant administrative privileges to other user accounts allowing the PT45 to have more than one administrative-level user.

---

**NOTE:** You cannot remove administrative privileges from the **admin** user unless another user has already been given administrative access level privileges created. For security, Server Technology recommends first creating a new administrative user account with administrative rights before removing the default account **admin**.

---

### *To set the access level privilege for a user:*

At the Switched CDU: prompt, type **set user access**, followed by **admin**, **poweruser**, **user**, **rebootonly**, **ononly** or **viewonly**, optionally followed by a username and press **Enter**.

### **Examples**

The following command sets the user access level for JohnDoe to Admin:

```
Switched CDU: set user access admin johndoe<Enter>
```

The following command sets the user access level for JaneDoe to User:

```
Switched CDU: set user access user janedoe<Enter>
```

## Granting and removing input load viewing privileges:

The Set User Envmon command grants or removes input status viewing privileges to/from a user.

### *To grant or remove input load viewing privileges for a user:*

At the Switched CDU: prompt, type **set user envmon** followed by **on** or **off**, optionally followed by a username and press **Enter**.

### **Example**

The following command grants input load privileges to the user JohnDoe:

```
Switched CDU: set user envmon on johndoe<Enter>
```

## Displaying the access privilege levels:

The List Users command displays all defined users with their access privilege level.

### *To display user access privilege levels:*

At the Switched CDU: prompt, type **list users** and press **Enter**.

### **Example**

The following command displays all users with their access privilege level:

```
Switched CDU: list users<Enter>
User          Privilege   Environmental
Name          Level       Monitoring
JOHNDOE       Admin       Allowed
JILLDOE       Power-User  Allowed
JANEDOE       User        Allowed
JAKEDOE       Reboot-Only Not Allowed
JOSEYDOE      On-Only     Not Allowed
JOEDOE        View-Only   Not Allowed
```



### Adding outlet access to a user:

The Add OutletToUser command grants a user access to one or all outlets. To grant access for more than one outlet, but not all outlets, you must use multiple Add OutletToUser commands.

#### *To grant outlet access to a user:*

At the Switched CDU: prompt, type **add Outlettouser**, optionally followed by an outlet name and a username. Press **Enter**, or

Type **add outlettouser all**, followed by a username and press **Enter**.

#### **Examples**

The following commands grant the user JaneDoe access to outlets A1 and Webserver\_1:

```
Switched CDU:add outlettouser .a1 janedoe<Enter>
Switched CDU:add outlettouser WebServer_1 janedoe<Enter>
```

### Deleting outlet access for a user:

The Delete OutletFromUser command removes a user's access to one or all outlets. You cannot remove access to any outlet for an administrative level user.

#### *To delete outlet access for a user:*

At the Switched CDU: prompt, type **delete outletfromuser**, optionally followed by an outlet name and a username, and press **Enter**.

Or type **delete outletfromuser all**, followed by a username, and press **Enter**.

### Adding group access to a user:

The Add GroupToUser command grants a user access to a group. To grant access for more than one group, you must use multiple Add GroupToUser commands.

#### *To grant group access to a user:*

At the Switched CDU: prompt, type **add grouptouser**, optionally followed by a group name and a username. Press **Enter**.

#### **Examples**

The following commands grants to user JaneDoe access to the groups ServerGroup\_1 and ServerGroup\_2:

```
Switched CDU:add GroupToUser ServerGroup_1 janedoe<Enter>
Switched CDU:add GroupToUser ServerGroup_2 janedoe<Enter>
```

### Deleting group access for a user:

The Delete GroupFromUser command removes a user's access to a group. You cannot remove access to any group for an administrative level user.

#### *To delete group access for a user:*

At the Switched CDU: prompt, type **delete GroupFromUser**, optionally followed by a group name and a username. Press **Enter**.

### Adding serial port access to a user:

The Add PortToUser command grants a user access to the serial port.

#### *To grant serial port access to a user:*

At the Switched CDU: prompt, type **add porttouser console** and a username. Press **Enter**.

### Deleting serial port access for a user:

The Delete PortFromUser command removes a user's access to the serial port. You cannot remove access to the serial port for an administrative level user.

#### *To delete serial port access for a user:*

At the Switched CDU: prompt, type **delete portfromuser console** and a username. Press **Enter**.

## Displaying user outlet, group, and serial port access:

The List User command displays all accessible outlets, groups and serial ports for a user.

### *To display user outlet, group and serial port access:*

At the Switched CDU: prompt, type **list user**, optionally followed by a username. Press **Enter**.

### **Example**

The following command displays information about the user JaneDoe:

```
Switched CDU: list user janedoe<Enter>
Username: JANEDOE
  Outlet  Outlet
  ID      Name
  .A1     DataServer_1
  .A2     WebServer_1
Groups:
  ServerGroup_1
  ServerGroup_2
More (Y/es N/o): Y
Ports:
  Port      Port
  ID        Name
  Console   Console
```

JaneDoe can access the following outlets, groups and serial ports:

Outlet A1 which has a descriptive name of DataServer\_1,

Outlet A2 which has a descriptive name of WebServer\_1, group ServerGroup\_1 group ServerGroup\_2,

and the Console serial port.

## Outlet Administration

### **Setting the sequencing interval:**

The Set Outlet SeqInterval commands sets the power on sequencing interval for all outlets.

#### *To set the sequencing interval:*

At the Switched CDU: prompt, type **set outlet seqinterval all**, followed by a value from 0 to 15 (in seconds) and press Enter.

### **Setting the reboot delay:**

The Set Outlet RebootDelay commands sets the reboot delay for all outlets.

#### *To set the sequencing interval:*

At the Switched CDU: prompt, type **set outlet rebootdelay all**, followed by a value from 5 to 60 (in seconds) and press Enter.

### **Creating a descriptive outlet name:**

The Set Outlet Name command assigns a descriptive name to an outlet. You can use this name in commands that require an outlet name as an alternative to using the outlet's absolute name.

#### *To create an outlet name:*

At the Switched CDU: prompt, type **set outlet name** followed by the absolute outlet name, then a descriptive name of up to 24 alphanumeric and other typed characters - (ASCII 33 to 126 decimal) are allowed; spaces are not allowed; outlet names are not case sensitive. Press **Enter**.

### **Example**

The following command adds the descriptive name DataServer\_1 to outlet .a1:

```
Switched CDU: set outlet name .a1 DataServer_1<Enter >
```

## Setting the outlet wakeup state:

The Set Outlet Wakeup command set the default wakeup state for that outlet. In the event of a system-wide power loss, this state will be applied to the outlet when power is restored.

The wakeup state can be set to On, Off or Last. Upon restoration of system power; If set to On, the PT45 will apply power to that outlet. If set to Off, the unit will not apply power to that outlet. If set to Last, the unit will apply the last known power state.

### *To set the wakeup state:*

At the Switched CDU: prompt, type **set outlet wakeup**, followed by **on**, **off** or **last** and the outlet name. Press **Enter**.

### *Example*

The following command sets the wakeup state for outlet .a1 to off:

```
Switched CDU: set outlet wakeup off .a1<Enter>
```

## Setting the outlet Post-On delay:

The Set Outlet PostOnDelay command is used set the Post-On delay for an outlet. This feature allows the administrator to manage boot dependencies during power-on sequencing or group commands by delaying the sequencing of subsequent outlets after an outlet has been powered on.

---

**NOTE:** This delay is applied in addition to the general sequencing interval.

---

### *To set the outlet Post-On delay*

At the Switched CDU: prompt, type **set outlet postondelay**, followed by a value from 0 to 900 (in seconds) and press **Enter**.

### *Example*

The following command set the Post-On delay for outlet .a5 to 90 seconds:

```
Switched CDU: set outlet postondelay .a5 90<Enter>
```

## Displaying outlet information:

The Show Outlets command displays information about all outlets. This information includes:

- Sequencing and reboot timer values
- Descriptive outlet name, if applicable
- Outlet wakeup state and Post-On settings

### *To display outlet information:*

At the Switched CDU: prompt, type **show outlets** and press **Enter**.

### *Example*

The following command displays all outlet information:

```
Switched CDU: show outlets<Enter>

Outlet   Outlet           Wakeup   Post-On
ID       Name              State    Delay (seconds)
.A1      DataServer_1     On       0
.A2      WebServer_1      On       0
.A3      FileServer_1     On       0
.A4      TowerA_Outlet4   On       0
.A5      TowerA_Outlet5   On       90
.A6      TowerA_Outlet6   On       0
.A7      TowerA_Outlet7   On       0
.A8      TowerA_Outlet8   On       0
.A9      TowerA_Outlet9   On       0
.A10     TowerA_Outlet10  On       0
.A11     TowerA_Outlet11  On       0
.A12     TowerA_Outlet12  On       0
.A13     TowerA_Outlet13  On       0
.A14     TowerA_Outlet14  On       0
.A15     TowerA_Outlet15  On       0
.A16     TowerA_Outlet16  On       0

More (Y/es N/o):
Outlet Options:
Sequence Interval: 2 seconds
Reboot Delay:      15 seconds
```

## **Input Feed Administration**

### **Creating a descriptive infeed name:**

The Set Infeed Name command assigns a descriptive name to an infeed. This descriptive name is displayed when the Show Traps command is issued.

#### ***To create a infeed name:***

At the Switched CDU: prompt, type **set infeed name** followed by the absolute infeed name, then a descriptive name of up to 24 alphanumeric and other typed characters - (ASCII 33 to 126 decimal) are allowed; spaces are not allowed. Press **Enter**.

#### ***Example***

The following command adds the descriptive name HQ\_1\_Infeed\_A to the infeed on the PT45:

```
Switched CDU: set infeed name .aa HQ_1_Infeed_A<Enter>
```

### **Setting the infeed operational voltage**

The Set Infeed Voltage command is use to edit the input operational voltage.

#### ***To set the infeed operational voltage:***

At the Switched CDU: prompt, type **set infeed voltage**, followed by the absolute infeed name, and a value from 0 to 480. Press **Enter**.

#### ***Example***

The following commands sets the operational voltage for input .AA to 100V:

```
Switched CDU: set infeed voltage .aa 100<Enter>
```

### **Setting the infeed maximum load capacity**

The Set Infeed LoadMax command is use to edit the input maximum load capacity.

#### ***To set the infeed maximum load capacity:***

At the Switched CDU: prompt, type **set infeed loadmax**, followed by the absolute infeed name, and a value from 1 to 255 (in amperes). Press **Enter**.

#### ***Example***

The following commands sets the maximum load capacity for input .AA to 15 amperes:

```
Switched CDU: set infeed loadmax .aa 15<Enter>
```

### **Displaying infeed information:**

The Show Infeeds command displays information about all infeeds. This information includes the absolute and descriptive infeed names, operational voltages and maximum load capacities.

#### ***To display tower information:***

At the Switched CDU: prompt, type **show infeeds** and press **Enter**.

#### ***Example***

```
Switched CDU: show infeeds<Enter>
```

Input Feed ID	Input Feed Name	Input Feed Voltage	Input Feed Capacity (Amps)
.AA	HQ_1_Infeed_A	100	15
.AB	HQ_1_Infeed_B	120	20
.BA	HQ_2_Infeed_A	120	30
.BB	HQ_2_Infeed_B	120	30

## **Tower Administration**

### **Creating a descriptive tower name:**

The Set Tower Name command assigns a descriptive name to a tower. This descriptive name is displayed when the Show Traps command is issued.

#### ***To create a tower name:***

At the Switched CDU: prompt, type **set tower name** followed by the absolute tower name, then a descriptive name of up to 24 alphanumeric and other typed characters - (ASCII 33 to 126 decimal) are allowed; spaces are not allowed. Press **Enter**.

#### ***Example***

The following command adds the descriptive name Florida\_HQ\_1 to tower .a:

```
Switched CDU: set tower name .a Florida_HQ_1<Enter>
```

### **Setting the tower serial number:**

The Set Tower ProdSN command is use to set the product serial number.

---

**NOTE:** If set at the factory, you cannot edit the serial number.

---

#### ***To set the tower serial number:***

At the Switched CDU: prompt, type **set tower prodsn**, followed by the absolute tower name, and the tower serial number. Press **Enter**.

#### ***Example***

The following command sets the serial number for tower .A to 'AA06F011157':

```
Switched CDU: set tower prodsn .a AA06F011157<Enter>
```

### **Setting the tower model number:**

The Set Tower Model command is use to set the product model number.

---

**NOTE:** If set at the factory, you cannot edit the model number.

---

#### ***To set the tower model number:***

At the Switched CDU: prompt, type **set tower model**, followed by the absolute tower name, and the tower model number. Press **Enter**.

#### ***Example***

The following command sets the model number for tower .A to 'CW-8H1-C20':

```
Switched CDU: set tower prodsn .a CW-8H1-C20<Enter>
```

### **Setting the tower AC or DC voltage type:**

The Set Tower command is used to set the product input AC or DC voltage type.

---

**NOTE:** If set at the factory, you cannot edit the voltage type.

---

#### ***To set the tower AC/DC voltage type:***

At the Switched CDU: prompt, type **set tower**, followed by **ac** or **dc**, and the absolute tower name. Press **Enter**.

#### ***Example***

The following command sets the AC/DC voltage type for tower .A to AC:

```
Switched CDU: set tower ac.a<Enter>
```

## Setting the tower AC voltage type:

The Set Tower 3phase command is used to set the product input AC voltage type.

---

**NOTE:** If set at the factory, you cannot edit the voltage type.

---

### *To set the tower AC voltage type:*

At the Switched CDU: prompt, type **set tower 3phase**, followed by the absolute tower name and **yes** or **no**. Press **Enter**.

### **Example**

The following command sets the AC voltage type for tower .A to non-3-phase:

```
Switched CDU: set tower 3phase.a no<Enter>
```

## Displaying tower information:

The Show Towers command displays information about the PT45. This information includes the absolute and descriptive unit names, serial and model numbers, and voltage types.

### *To display tower information:*

At the Switched CDU: prompt, type **show towers** and press **Enter**.

### **Example**

```
Switched CDU: show towers<Enter>
Tower ID:      .A
Name:         TowerA
Product S/N:   AA06F011157
Model No.:    CW-8H1-C20
3-Phase:      No
Power Type:    AC
More (Y/es N/o):
```

## Group Administration

### Creating a group name:

The Create Group command creates a new group name.

#### *To create a group name:*

At the Switched CDU: prompt, type **create group** optionally followed by a descriptive name of up to 24 alphanumeric and other typed characters - (ASCII 33 to 126 decimal) are allowed; spaces are not allowed. Group names are not case sensitive. Press **Enter**.

### **Example**

The following command creates group name ServerGroup\_1:

```
Switched CDU: create group ServerGroup_1<Enter>
```

### Removing a group name:

The Remove Group command removes a group name.

#### *To remove a group name:*

At the Switched CDU: prompt, type **remove group**, optionally followed by a username. Press **Enter**.

### **Example**

The following command removes group name ServerGroup\_1:

```
Switched CDU: remove group ServerGroup_1<Enter>
```

### **Adding an outlet to a group:**

The Add OutletToGroup command adds an outlet to a group. To add more than one outlet, but not all outlets, you must use multiple Add OutletToGroup commands.

#### ***To add an outlet to a group:***

At the Switched CDU: prompt, type **add outlettogroup**, optionally followed by an outlet name and group name. Press **Enter**, or

Type **add OutletToGroup**, followed by **all** and the group name. Press **Enter**.

#### ***Examples***

The following commands use absolute outlet names to add outlets A1 and A2 to group name ServerGroup\_1:

```
Switched CDU:add OutletToGroup .a1 ServerGroup_1<Enter>
Switched CDU:add OutletToGroup .a2 ServerGroup_1<Enter>
```

The following commands use the outlets' descriptive names to add outlets DataServer\_1 and WebServer\_1 to group name ServerGroup\_1:

```
Switched CDU:add OutletToGroup DataServer_1 ServerGroup_1<Enter>
Switched CDU:add OutletToGroup WebServer_1 ServerGroup_1<Enter>
```

The following command add all outlets to group name ServerGroup\_1:

```
Switched CDU: add OutletToGroup<Enter>
Outletname: all<Enter>
Groupname: ServerGroup_1<Enter>
```

### **Deleting an outlet from a group:**

The Delete OutletFromGroup command deletes an outlet from a group. To delete more than one outlet, but not all outlets, you must use multiple Delete OutletToGroup commands.

#### ***To delete an outlet from a group:***

At the Switched CDU: prompt, type **delete outletfromgroup**, optionally followed by an outlet name and a group name. Press **Enter**, or

Type **delete outletfromgroup**, followed by **all** then the group name. Press **Enter**.

## **Environmental Monitor Administration**

### **Creating a descriptive Environmental Monitor name:**

The Set Envmon Name command assigns a descriptive name to the integrated Environmental Monitor. This descriptive name is displayed when the Evnmon command is issued.

#### ***To create an Environmental Monitor name:***

At the Switched CDU: prompt, type **set envmon name** followed by the absolute environmental monitor name, then the descriptive name of up to 24 alphanumeric and other typed characters - (ASCII 33 to 126 decimal) are allowed; spaces are not allowed. Press **Enter**.

#### ***Example***

The following command adds the descriptive name Florida\_HQ\_1 to the Environmental Monitor:

```
Switched CDU: set envmon name .a Florida_HQ_1<Enter>
```

### **Creating a descriptive temperature/humidity sensor name:**

The Set Envmon THS Name command assigns a descriptive name to a temperature/humidity sensor. This descriptive name is displayed when the Evnmon command is issued.

#### ***To create an temperature/humidity sensor name:***

At the Switched CDU: prompt, type **set envmon ths name** followed by the absolute name of the temperature/humidity sensor, then the descriptive name of up to 24 alphanumeric and other typed characters - (ASCII 33 to 126 decimal) are allowed; spaces are not allowed. Press **Enter**.

#### ***Example***

The following command adds the descriptive name T/H2\_Florida\_HQ\_1 to the second temperature/humidity sensor:

```
Switched CDU: set envmon ths name .a2 T/H2_Florida_HQ_1<Enter>
```

## **Serial Port Administration**

### **Creating a descriptive serial port name:**

The Set Port Name command assigns a descriptive name to a serial port. You can use this name in commands that require a port name as an alternative to using the port's absolute name.

#### ***To create an port name:***

At the Switched CDU: prompt, type **set port name** followed by the absolute outlet name, then a descriptive name of up to 24 alphanumeric and other typed characters - (ASCII 33 to 126 decimal) are allowed; spaces are not allowed; port names are not case sensitive. Press **Enter**.

#### ***Example***

The following command adds the descriptive name Rack1 to Console port:

```
Switched CDU: set port name console Rack1<Enter>
```

### **Setting the serial ports data-rate:**

The Set Port Speed command sets the default data-rate for the serial port. Valid data-rates are 1200, 2400, 4800, 9600, 19200, 38400, 57600 and 115200.

#### ***To set the serial port data-rate:***

At the Switched CDU: prompt, type **set port speed**, follow by the data-rate and press **Enter**.

#### ***Example***

The following command sets the serial ports data-rate to 38400 BPS:

```
Switched CDU: set port speed 38400<Enter>
```

### **Enabling or disabling active signal checking for serial connections:**

The Set Port DSRCheck command enables or disables active signal checking for serial connections to devices attached to any of the available serial ports.

#### ***To enable or disable active signal checking for serial connections:***

At the Switched CDU: prompt, type **set port dsrcheck console, on or off**, and press **Enter**.

### **Setting the serial port timeout value:**

The Set Port Timeout command sets the serial port inactivity timeout period. The timeout period defines the maximum period of inactivity before automatically closing the Pass-Thru session.

The valid range for the timeout is 0 to 60 (in minutes). The default timeout is 5 minutes. The command can be used to set individual ports by ID or name.

---

#### **NOTES:**

- Setting the timeout value to "0" disables the timer.
  - Only a numeric value is accepted.
- 

#### ***To set the serial port timeout value for an individual port:***

At the Switched CDU: prompt, **type set port timeout**, followed by the port ID or name, followed by a timeout value from 0 to 60 (in minutes), and press **Enter**.



## Configuring the Bluetooth™ options:

If the PT45 has been equipped for the mobile monitoring solution using Bluetooth® technology, several Bluetooth parameters will be available for editing on the Serial Ports configuration page.

### *To set the Bluetooth™ module name:*

The Bluetooth™ module name displays in the list of discovered modules on the Android device. The default is “ST Eye”, and the module name cannot be blank.

At the Switched CDU: prompt, type **set bluetooth name**, followed by 1-31 characters of a descriptive name for the module, and press **Enter**.

### *To set the Bluetooth™ discoverability:*

Three discoverability settings determine the current status of the pushbutton on the Bluetooth module:

- Always - The Bluetooth module is discoverable, even without pressing the pushbutton.
- Limited (Default) - The pushbutton on the Bluetooth module must be pressed to make the module discoverable for 60-seconds.
- Never - The Bluetooth module is never in discoverable mode.

At the Switched CDU: prompt, type **set bluetooth discover**, followed by **always**, **limited**, or **never**, and press **Enter**.

### *To set the Bluetooth™ pin code:*

The pin code is available for legacy Bluetooth modules that require a pin to pair the module. Although not used in current Bluetooth modules, the pin code is supported if needed. The default is 9611.

At the Switched CDU: prompt, type **set bluetooth pincode**, followed by 4-digits from 0000 to 9999, and press **Enter**.

### *To set the Bluetooth™ transmission power:*

This setting is the designated transmission power (dbm) for the Bluetooth module. Note that lowering the transmission power reduces the effective range of the module. Default is 0

At the Switched CDU: prompt, type **set bluetooth transpwr**, followed by a value from -6 to 4 (dbm), and press **Enter**.

## Enabling or disabling the Command Line Interface (CLI):

This option enables or disables availability of the CLI for issuing action commands to the PDU. If disabled, only the firmware Web user interface will be available.

### **To enable or disable the CLI:**

At the Switched CDU: prompt, type **set port cli**, follow by the serial port name, followed by **enabled** or **disabled**, and press **Enter**.

## Enabling or disabling the Serial Command Protocol (SCP):

This option allows SCP functions to be enabled or disabled for a specific serial port.

### *To enable or disable the SCP:*

At the Switched CDU: prompt, type **set port scp**, follow by the serial port name, followed by **enabled** or **disabled**, and press **Enter**.

## Enabling or disabling the Serial Command Protocol (SCP) emulation:

This option notifies SCP of an MRV device on a specific serial port.

### *To enable or disable the SCP emulation:*

At the Switched CDU: prompt, type **set port scp**, followed by **emulate**, followed by **none** or **MRV**, and press **Enter**.

### Enabling or disabling the RFTAG option:

This option makes RF Code sensor tags available for the Server Technology wireless monitoring solution.

#### *To enable or disable the RF Code sensor options:*

At the Switched CDU: prompt, type **set port rftag**, follow by the serial port name, followed by **enabled** or **disabled**, and press **Enter**.

### Displaying serial port information:

The Show Ports command displays information about all serial ports. This information includes:

- Serial port data rate
- Descriptive port name, if applicable
- DSR signal checking settings

#### *To display serial port information:*

At the Switched CDU: prompt, type **show ports** and press **Enter**.

#### **Example**

The following command displays all serial port information:

```
Switched CDU: show ports<Enter>
Serial Port Configuration
  ALL Ports:
    Baud Rate: 38400      Connection Timeout: 5 minute<s>
    Port ID: Console     Port Name: CONSOLE
    DSR Check: ON
```

## **System Administration**

### **Creating a pre-login banner:**

The Set Banner command specifies text that appears prior to the login authentication. This feature allows administrators to configure a message up to 2069 characters for display of legal, disclaimer or other text as required by application. If left blank, the user will be taken directly to the login prompt.

---

#### **NOTES:**

##### *For SSH sessions only:*

- The “keyboard-interactive” authentication method must be used for the banner to display.
  - Banner length is truncated to 1500 bytes in SSH packets to avoid failure of SSH connection when configured with a long login banner.
- 

#### ***To create a pre-login banner:***

At the Switched CDU: prompt, type **set banner** and press **Enter**. Type the desired pre-login banner text and when finished type **Ctrl-z**.

### **Creating a location description:**

The Set Location command specifies text that appears in the Web control screen’s Location field. The text is also appended to a Welcome to banner that appears when a user successfully logs in serially or through a Telnet session.

If you do not issue this command, or if you issue this command without specifying any text, the control screen’s Location field will be blank and no Welcome to banner will be displayed.

#### ***To create a location description:***

At the Switched CDU: prompt, type **set location** followed by a descriptive name of up to 24 alphanumeric and other typed characters - (ASCII 33 to 126 decimal) are allowed; spaces are allowed. Press **Enter**.

Omitting any characters after typing ‘set location’ deletes any previously specified text.

#### ***Examples***

The following command specifies Florida HQ as the descriptive location for the control screen and the login banner:

```
Switched CDU: set location Florida HQ<Enter>
```

The following command deletes any previously specified location description:

```
Switched CDU: set location<Enter>
```

In this case, the control screen’s Location field will be blank, and no welcome banner will be displayed after a successful login.

### **Setting the system area:**

The Set System Area command is used to set the total area for the system. This value is used for total system power calculations.

#### ***To set the system area:***

At the Switched CDU: prompt, type **set system area**, followed by the system area (in square feet) and press **Enter**.

#### ***Example***

The following command sets the total system area to 6.3 square feet:

```
Switched CDU: set system area 6.3<Enter>
```

### **Setting the system area unit of measure:**

The Set System Area Unit command sets the value for the system area footprint in either square meters or square feet.

The default unit of area is a square meter.

#### ***To set the system area unit of measure:***

At the Switched CDU: prompt, type **set system areaunit**, followed by **squaremeter** or **squarefoot**, and press **Enter**.

### Setting the system power factor:

The Set System PF command sets the power factor used in the total system power calculation. The valid range is .50 to 1.00.

#### *To set the power factor:*

At the Switched CDU: prompt type **set system pf**, followed by the power factor, and press **Enter**.

#### **Example**

The following command sets the system input power factor to 0.8:

```
Switched CDU: set system pf .8<Enter>
```

### Setting the system 3-phase load out-of-balance threshold:

The Set System Balance command determines when the current on the lines of a 3-phase system are out-of-balance between the three phases of power.

#### *To set the 3-phase load out-of-balance threshold:*

At the Switched CDU: prompt, type **set system balance**, followed by the load out-of-balance threshold (in percent), and press **Enter**.

#### **Example:**

The following command sets the 3-phase load out-of-balance threshold to 20%.

```
Switched CDU: set system balance 20<Enter>
```

### Setting the 3-phase load out-of-balance alert:

The Set System Balance Alert command enables or disables the sending of an alert when the current on the lines of a 3-phase system are past a pre-set threshold (percentage) and are out-of-balance between the three phases of power.

At the Switched CDU: prompt, type **set system balancealert**, followed by **enabled** or **disabled**, and press **Enter**.

#### **Example:**

The following command enables the load out-of-balance alert:

```
Switched CDU: set system balancealert enabled<Enter>
```

---

#### **NOTES:**

- When a device with 3-phase input voltage is out-of-balance, efficiency is reduced and the unit is prevented from reaching maximum capacity. When an alert for the out-of-balance condition is received (if the alerting feature is enabled), it may be necessary to adjust distribution of the loads.
  - For 3-phase systems, if the Out-of-Balance Alerting feature is enabled, and the system goes into a load out-of-balance condition, the System Status command will display the alert “3ph Out-of-Balance” in the Tower Status section, unless there is a higher priority tower error state to report.
-

## Displaying system configuration information:

The Show System command displays all system configuration information.

- Firmware version
- NIC module serial number and MAC address
- Hardware revision code and Flash size
- Uptime since last system restart
- System location description
- System area, input power factor and 3-phase load out-of-balance threshold.

### *To display system configuration information:*

At the Switched CDU: prompt, type **show system** and press **Enter**.

#### **Example**

```
System Information
  F/W Version:      Switched CDU Version 6.1f
  NIC S/N:          8217984
  MAC Address:      00-0a-9c-10-00-01
  H/W Rev Code:     32 (ME)
  Flash Size:       2 MB
  Uptime:           59 days 6 hours 14 minutes 34 seconds
  Location:         Florida HQ
  Area <Footprint>: 4.5 square feet
  Power Factor:     0.88
  3-Phase Load
    Out-of-Balance
    Threshold:      20 percent
```

## Displaying system power status:

The System Status command displays all power status information.

### *To display system power status:*

At the Switched CDU: prompt, type **sysstat** and press **Enter**.

#### **Example**

```
Switched CDU: sysstat
System Power Status
  Total Power Consumption: 170 Watts
  Area <Footprint>:       100.0 Square Meters
  Watts Per Area Unit:    2 Watts Per Square Meter
Tower Status
  Tower   Tower   Tower
  ID      Name     Status
  .A      TowerA   Normal
  .B      TowerB   Normal

Command successful
```

---

**NOTE:** For 3-phase systems, if the Out-of-Balance Alerting feature is enabled, and the system goes into a load out-of-balance condition, the System Status command will display the alert “3ph Out-of-Balance” in the Tower Status section, unless there is a higher priority tower error state to report.

---

## Configuring the LED display orientation:

The Set Option Display command configures the LED display orientation.

### *To configure the LED display orientation:*

At the Switched CDU: prompt, type **set option display**, followed by **normal**, **inverted**, or **auto**, and press **Enter**.

### **Example**

The following sets the LED display orientation to Inverted:

```
Switched CDU: set option display inverted<Enter>
```

---

### **NOTES:**

- Only specific PT45 models are equipped with an accelerometer chip that senses device orientation. If equipped, your unit automatically aligns the LED display orientation depending on its current direction, and “Auto” will display in the Show Options command by default. In addition, the actual mounting of the unit, such as such as “<Normal> or <Inverted>”, appears to the right of the “Auto” option when you issue the Show Options command. However, even if your model does have the sensor for device orientation, you can still issue the Set Option Display command with either the Normal or Inverted option to override the capability of the hardware.
  - If your model does not have the accelerometer chip, you will need to configure the LED display orientation by entering the Normal or Inverted option.
- 

## Enabling or disabling strong passwords:

The Set Option Strong Password command is used to enable or disable the requirements for strong passwords. When enabled, all new passwords must be a minimum of 8 characters in length with at least one uppercase letter, one lowercase letter, one number and one special character.

### *To enable or disable strong passwords:*

At the Switched CDU: prompt, type **set option strong password**, followed by **enabled** or **disabled** and press **Enter**.

## Enabling or disabling the external configuration reset button:

The Set Option Button command enables or disables the external configuration reset button. This feature can enhance system security by protecting the PT45 configurations from being reset locally.

**NOTE:** If this feature has been enabled and the administrative account username/password has been lost, then the PT45 must be returned to the factory for non-warranty reset of the configuration.

---

### *To enable or disable the configuration reset button:*

At the Switched CDU: prompt, type **set option button**, followed by **enabled** or **disabled** and press **Enter**.

## Enabling or disabling the ‘more’ prompt:

The Set Option More command enables or disables the ‘more’ prompt for display of data larger than the terminal window.

### *To enable or disable ‘more’:*

At the Switched CDU: prompt, type **set option more**, followed by **enabled** or **disabled** and press **Enter**.

## Setting the temperature scale:

The Set Option TempScale command sets the temperature scale that the PT45 will report in.

### *To set the temperature scale:*

At the Switched CDU: prompt, type **set option tempscale**, followed by **celsius** or **fahrenheit** and press **Enter**.

## Configuring the Command Line Interface (CLI) session timeout:

The Set Option CLI Timeout command configures the CLI session timeout in minutes.

The valid timeout range is 1 to 1440 minutes (24 hours). The default session timeout is 5 minutes.

### *To configure the CLI Session Timeout:*

At the Switched CDU: prompt, type **set option clitimeout**, followed by the session timeout (in minutes), and press **Enter**.

### **Example:**

The following command sets the CLI session timeout to 15 minutes:

```
Switched CDU: set option clitimeout 15<Enter>
```

---

## Configuring the web session (Web Interface) timeout:

The Set Option Web Timeout command configures the Web session timeout in minutes.

The valid timeout range is 1 to 1440 minutes (24 hours). The default session timeout is 5 minutes.

### *To configure the web session timeout:*

At the Switched CDU: prompt, type **set option webtimeout**, followed by the session timeout (in minutes), and press **Enter**.

### *Example:*

The following command sets the web session (Web Interface) timeout to 10 minutes:

```
Switched CDU: set option webtimeout 10<Enter>
```

## Customizing the CLI prompt:

The Set Option Prompt command customizes the CLI prompt.

### *To customize the CLI prompt:*

At the Switched CDU: prompt, type **set option prompt** and press **Enter**. Then type the custom prompt and press **Enter**.

To reset the custom prompt to the default prompt, type **set option prompt** and press **Enter**. When prompted, leave blank and press **Enter**.

The maximum length of the custom prompt is 31 characters. Spaces and special characters are allowed.

### *Example:*

The following command sets the default CLI prompt to “My Prompt”:

```
Switched CDU: set option prompt<Enter>
Custom prompt <blank for default>: My Prompt:
Command successful
My Prompt:
```

## Enabling or Disabling StartUp Stick®:

The Set Option Startupstick command enables or disables the StartUp Stick tool for PDU mass configuration of operating parameters.

### *To enable or disable StartUp Stick:*

At the Switched CDU: prompt, type **set option startupstick**, followed by **enabled** or **disabled** and press **Enter**.

## To enable or disable coldboot alert:

Upon a coldboot of the system (if the Coldboot Alert feature is enabled), the system sends a ½ second RS-232 break out on any serial ports that are also enabled.

The Set Option Coldboot Alert command enables or disables the Coldboot Alert feature.

### *To enable or disable coldboot alert:*

At the Switched CDU: prompt, type **set option cbalert**, followed by **enabled** or **disabled**, and press **Enter**

## To enable or disable the Serial Command Protocol (SCP) authentication:

The Set SCP Authentication command enables or disables SCP Authentication.

### *To enable or disable SCP:*

At the Switched CDU: prompt, type **set scpauth**, followed by **enabled** or **disabled**, and press **Enter**.

## To set the Serial Command Protocol (SCP) authentication user:

The Set SCPAuth User command sets the username and password for SCPAuthentication.

### *To set SCP username:*

At the Switched CDU: prompt, type **set scpauth user**, followed by user name, and press **Enter**. You will be prompted to enter and verify a password.

## Displaying system options:

The Show Options command displays all system option information.

### *To display system option information:*

At the Switched CDU: prompt, type **show options** and press **Enter**.

### **Example**

```
Sentry: show options
System Options
  Display Orientation:      Auto <Normal>
  Outlet Sequence Order:   Normal
  Strong Passwords:        Disabled
  Configuration Reset Button: Enabled
  More Prompt:             Enabled
  Temperature Scale:       Celsius
  CLI Custom Prompt:       <none>
  CLI Session Timeout:     10 minutes
  Web Session Timeout:     10 minutes
  Coldboot Alert <SCP>:    Enabled
  StartUp Stick:           Enabled
```

---

**NOTE:** The display of "<SCP>" after the Coldboot Alert parameter in the Show Options command (as indicated above) shows a relationship between the Serial Command Protocol (SCP) and the Coldboot Alert feature. Upon a coldboot of the system, if the Coldboot Alert feature is enabled, the system will send a ½ second RS-232 break out to to any SCP-enabled serial ports.

---



## Displaying the firmware version:

The Version command displays the firmware version.

### *To display the firmware version:*

At the Switched CDU: prompt, type **version** and press **Enter**.

## Performing a warm boot:

The Restart command performs a warm boot of the PT45.

---

**NOTE:** System user/outlet/group/port configuration or outlet states are not changed or reset with the Restart command.

---

### *To perform a warm boot:*

At the Switched CDU: prompt, type **restart** and press **Enter**.

## Enabling or disabling the Cisco EnergyWise network:

---

**NOTE:** Only commands through the CLI are supported for the Cisco EnergyWise network. There is no firmware web-based interface for EnergyWise. Enabling EnergyWise requires a system restart.

---

The Set EnergyWise command enables or disables the EnergyWise network support:

### *To enable or disable EnergyWise:*

At the Switched CDU: prompt, type **set energywise**, followed by **enabled** or **disabled**, and press **Enter**.

### **Example**

```
Switched CDU: set energywise enabled
Command successful -- restart required
```

## Setting up PDUs in the Cisco EnergyWise network:

---

**NOTE:** To use EnergyWise, you must first configure domain name, port, and secret.

---

The Set EnergyWise Domain command configures the EnergyWise domain the PT45 belongs to. The limit of the Domain Name is 64 characters.

### *To set the EnergyWise domain name:*

At the Switched CDU: prompt, type **set energywise domain**, followed by the domain name, and press **Enter**.

### **Example**

```
Switched CDU: set energywise domain 10.1.2.120
Command successful
```

### *To set the EnergyWise port:*

The default port number is 43440; the valid range for port numbers is 1-65535.

At the Switched CDU: prompt, type **set energywise port**, followed by the port number, and press **Enter**.

### **Example**

```
Switched CDU: set energywise port
Port [666]: 700
Command successful
```

### ***To set the EnergyWise secret:***

The limit of the Secret field is 64 characters. A blank secret is also acceptable.

At the Switched CDU: prompt, type **set energywise secret**, then verify the secret, and press **Enter**.

#### ***Example***

```
Switched CDU: set energywise secret
Secret: *****
VerifySecret: *****
Command successful
```

### ***To set a blank EnergyWise secret:***

A blank secret is acceptable.

At the Switched CDU: prompt, type **set energywise secret**, do not type in the Secret field, and press **Enter** twice (to bypass the Secret field and then VerifySecret field.)

#### ***Example of a blank secret***

```
Switched CDU: show energywise

EnergyWise Configuration
Endpoint:           Enabled *
Port:               666
Domain:
Refresh Rate:      60
Secret:             (Blank)
Command successful
```

### ***To set the EnergyWise refresh rate:***

The EnergyWise refresh rate is the rate (in seconds) at which new information is pushed to the EnergyWise manager. Valid range is 30-600 seconds; default is new data sent to the EnergyWise manager every 3 minutes.

At the Switched CDU: prompt, type **set energywise refresh**, followed by a rate (in seconds) from 30-600, and press **Enter**.

## **Viewing Cisco EnergyWise network parameters:**

---

**NOTE:** A change in any value (shown in the example below) requires a restart of the system.

---

### ***To view EnergyWise network parameters:***

At the Switched CDU: prompt, type **show energywise**, and press **Enter**.

#### ***Example***

```
Switched CDU: show energywise

EnergyWise Configuration
Endpoint:           Enabled*
Port:               666
Domain:             <undefined>
Refresh Rate:      55
Secret:             *****
Command successful
```

## **TCP/IP Administration**

---

**NOTE:** You will need to restart the PT45 after setting or changing any TCP/IP configurations.

---

### **Enabling or disabling DHCP support:**

The Set DHCP command enables or disables DHCP support.

#### ***To enable or disable DHCP support:***

At the Switched CDU: prompt, type **set dhcp**, followed by **enabled** or **disabled**, and press **Enter**.

### **Enabling or disabling DHCP boot delay:**

The Set DHCP Boot Delay command enables or disables the DHCP boot delay option.

- Enabling the Boot Delay option gives the PT45 approximately 100-seconds to establish a connection through a DHCP server. This interval allows various network component activities to occur as the unit powers up (such as obtaining SNTP time stamps for logging or allowing SNMP traps to be sent as switched outlets power up). This is the default state.
- Disabling the Boot Delay option forces the unit to boot after approximately 5-seconds regardless of the DHCP acquisition state. This speeds up a boot when a DHCP server is connected to one of the PDU's outlets. In this configuration, SNMP traps, SNTP and other protocols will not be available until a DHCP address has been resolved.

#### ***To enable the boot delay:***

At the Switched CDU: prompt, type **set dhcp**, followed by **bootdelay**, followed by **enabled** or **disabled**, and press **Enter**.

---

#### **NOTES:**

- The Boot Delay option executes only when DHCP is enabled.
  - The firmware can detect network link integrity and will wait for network connection. This means that if the network is not currently connected, the enabled Boot Delay option will be ignored.
- 

### **Enabling or disabling DHCP static address fallback:**

**NOTE:** DHCP must be enabled to activate the DHCP Static Address Fallback option.

---

The Set DHCP Static Address Fallback command enables or disables the DHCP static address fallback option.

Enabling the Static Address Fallback option informs the PT45 to automatically fall back to a static address if a DHCP server does not respond after 100-seconds. This is the default state.

Disabling the Static Address Fallback option generates periodic DHCP server requests until the unit obtains a dynamic address.

#### ***To enable the static address fallback:***

At the Switched CDU: prompt, type **set dhcp**, followed by **staticfallback**, followed by **enabled** or **disabled**, and press **Enter**.

**NOTE:** If the DHCP server boot time is excessive, you may need to disable the DHCP Static Address Fallback option.

---

### **Setting the network acquisition method:**

The Set Net command determines the acquisition method used for the protocol stack and IPv4/IPv6 address.

For a detailed description of the Disabled, IPv4 only, and Dualv6v4 options, see [Network-Enabled Modes](#).

At the Switched CDU prompt: type **set net**; followed by **disabled**, **ipv4only**, or **dualv6v4**; and press **Enter**.

## Setting the IP address:

The Set IP Address command sets the TCP/IP address of the network interface controller.

### *To set the IP address:*

At the Switched CDU: prompt, type **set ipaddress**, followed by the IP address and press **Enter**.

---

**NOTE:** Both IPv4 and IPv6 IP address formats are accepted.

---

### **Example**

The following command sets the IP address to 12.34.56.78:

```
Switched CDU: set ipaddress 12.34.56.78<Enter>
```

## Setting the subnet mask:

The Set Subnet command sets the subnet mask for the network the PT45 will be attached to.

### *To set the subnet mask:*

At the Switched CDU: prompt, type **set subnet**, followed by the subnet mask and press **Enter**.

### **Example**

The following command sets the subnet mask to 255.0.0.0

```
Switched CDU: set subnet 255.0.0.0<Enter>
```

## Setting the gateway:

The Set Gateway command sets the IP address of the default gateway the PT45 uses to access external networks.

### *To set the gateway IP address:*

At the Switched CDU: prompt, type **set gateway**, followed by the gateway IP address and press **Enter**.

### **Example**

The following command set the gateway IP address to 12.34.56.1:

```
Switched CDU: set gateway 12.34.56.1<Enter>
```

## Setting the DNS IP address:

The Set DNS command sets the TCP/IP address of the Domain Name server (DNS).

### *To set the DNS IP address:*

At the Switched CDU: prompt, type **set**, followed by **dns1** or **dns2** and the Domain Name server's IP address. Press **Enter**.

---

**NOTE:** Both IPv4 and IPv6 formats are accepted for DNS IP address.

---

### **Example**

The following command sets the primary Domain Name server IP address to 98.76.54.254:

```
Switched CDU: set dns1 98.76.54.254<Enter>
```

## Displaying network configuration information:

The Show Network command displays TCP/IP, Telnet, SSH, Web, SSL, SNMP, and DHCP options (when DHCP is enabled) configuration information. The Show Network command also displays all IPv4 and IPv6 settings.

- Network configuration: IP address, subnet mask, gateway and DNS IP addresses (both IPv4 and IPv6 formats are displayed). (both IPv4 and IPv6 formats are displayed).
- Enabled-disabled status and port numbers for Telnet, SSH, HTTP, SSL, SNMP, and FTP Server support.
- Network status: Link, speed, duplex, and negotiation.
- DHCP boot delay and DHCP static address fallback options (when DHCP is enabled).
- Enabled-disabled status of Sentry Power Manager (SPM).

### **To display network configuration information:**

At the Switched CDU: prompt, type **show network** and press **Enter**.

### **Example**

The following command displays the network configuration information:

```
Switched CDU: show network<Enter>
Network Settings
  State: DHCP IPv6/IPv4 Network: Dual IPv6/IPv4
  Link: Up Negotiation: Auto
  Speed: 100 Mbps Duplex: Full

  AutoCfg IPv6: FE80::20A:9CFF:FE52:4104/64
  IPv6 Address: FD01::1:B51A:E03C/64
  IPv4 Address: 10.1.6.230 Subnet Mask: 255.255.0.0
  IPv4 Gateway: 10.1.1.1
  DNS1: FD01::A01:585
  DNS2: 10.1.5.133

Static IPv4/IPv6 Settings
  IPv6 Address: FD01::A01:353/64
  IPv6 Gateway: ::
  IPv4 Address: 10.1.2.253 Subnet Mask: 255.255.0.0
  IPv4 Gateway: 10.1.1.1
  DNS1: 10.1.5.133
  DNS2: 10.1.5.134

DHCP Settings
  DHCP: Enabled
  FQDN: Enabled [sentry3-524104]
  Boot Delay: Enabled
  Static Fallback: Enabled

Network Services
  Telnet: Enabled Port: 23
  SSH: Enabled Port: 22 Auth: Password, Kb-Int
  HTTP: Enabled Port: 80
  SSL: Enabled Port: 443 Installed Cert: User Encrypted
  Access: Optional Stored Files: Cert & Key
  User Cert: Enabled User Passphrase: <set>
  SNMPv1/2: Enabled Port: 161 TrapPort: 162
  SNMPv3: Disabled Port: 161 TrapPort: 162
  FTP Server: Enabled Port: 21
  SPM Access: Enabled

Command successful
```

---

**NOTE:** The fields IPv4 Address, IPv4 Subnet Mask, IPv4 Gateway, DNS1, and DNS2 are equivalent to existing PT45 IPv4 settings except that current network settings and static settings are displayed separately. This allows you to view both static configuration settings and active network settings that can be obtained using DHCP. The DNS addresses can be IPv4 or IPv6 format at this time (based on RFC4291).

---

## HTTP Administration

---

**NOTE:** A restart is required after setting or changing any Telnet/Web configurations.

---

### Enabling and disabling HTTP support:

The Set HTTP command is used to enable or disable HTTP support.

#### *To enable or disable HTTP support:*

At the Switched CDU: prompt, type **set http**, followed by **enabled** or **disabled** and press **Enter**.

### Changing the HTTP server port:

With HTTP support enabled, the HTTP server watches and responds to requests on the default HTTP port number 80. This port number can be changed using the Set HTTP Port command.

#### *To change the HTTP port:*

At the Switched CDU: prompt, type **set http port**, followed by the port number and press **Enter**.

#### **Example**

The following changes the HTTP port number to 2048:

```
Switched CDU: set HTTP port 2048<Enter>
```

### Sentry Power Manager (SPM) Administration:

The Sentry Power Manager (SPM) is Server Technology's enterprise management software product for the data center. The configuration options provided allow you to enable/disable SPM and reset the SPM password to its default.

---

**NOTE:** The SPM options apply only if you are currently using Server Technology's SPM software product.

---

### Enabling and disabling SPM Secure Access:

The Set SPM command enables or disables support for Sentry Power Manager (SPM). If your operation does not currently use SPM software, you can disable SPM Secure Access. However, if disabled, the PT45 will not be able to use the SPM suite of secure network capabilities or the advanced remote configuration.

#### *To enable or disable SPM support:*

At the Switched CDU: prompt, type **set spm**, followed by **enabled** or **disabled** and press **Enter**.

---

**NOTE:** Both HTTP and SSL must be enabled or the SPM Secure Access option will not be permitted. When SPM Secure Access is permitted, the default is Enabled.

---

### Resetting the SPM Password:

The Set SPM Reset Password command resets the SPM password on the unit to its internal default password.

Each PT45 has a default unique SPM password that is used to communicate between SPM and the unit. When SPM discovers a PT45 in the network, SPM changes this password into a different unique password for added security. The SPM then continues to manage or alter these passwords as required for system security.

If a unit is relocated or swapped from the system after a password was generated, SPM may not be able to re-establish a connection to the unit. The Set SPM Reset Password command allows you to reset to the internal default password of the unit so SPM can re-discover the device and add it to the system. Once the unit has been acquired by SPM, no further action is necessary.

#### *To reset the SPM password:*

At the Switched CDU: prompt, type **set spm**, followed by **resetpw** and press **Enter**.

---

**NOTE:** Do not reset the password if SPM communication has already been established.

---

## **Telnet Administration**

---

**NOTE:** A restart of the PT45 is required after setting or changing any Telnet/Web configurations.

---

### **Enabling and disabling Telnet support:**

The Set Telnet command is used to enable or disable Telnet support.

#### ***To enable or disable Telnet support:***

At the Switched CDU: prompt, type **set telnet**, followed by **enabled** or **disabled** and press **Enter**.

### **Changing the Telnet port:**

With Telnet support enabled, the Telnet server watches and responds to requests on the default Telnet port number 23. This port number can be changed using the Set Telnet Port command.

#### ***To change the Telnet socket:***

At the Switched CDU: prompt, type **set telnet port**, followed by the port number and press **Enter**.

### ***Example***

The following changes the Telnet port number to 7001:

```
Switched CDU: set telnet port 7001<Enter>
```

## **FTP Administration**

You can upload new versions of firmware into the PT45 using File Transfer Protocol (FTP). This allows access to new firmware releases for firmware improvements and new features additions. The following commands are used to configure the unit for an FTP firmware upload.

---

**NOTE:** Secure File Transport Protocol (SFTP) is also supported for encrypted SSH transport over the network.

---

### **Setting the FTP host address:**

The Set FTP Host command sets the FTP host IP address or hostname allowing for firmware file uploads.

#### ***To set the FTP Host address:***

At the Switched CDU: prompt, type **set ftp host**, followed by the IP address or hostname and press **Enter**.

---

**NOTE:** Both IPv4 and IPv6 formats are accepted for IP address or hostname.

---

### **Examples**

The following command sets the FTP host IP address to 12.34.56.99:

```
Switched CDU: set ftp host 12.34.56.99<Enter>
```

The following command sets the FTP hostname to ftp.servertech.com:

```
Switched CDU: set ftp host ftp.servertech.com<Enter>
```

### **Setting the FTP username:**

The Set FTP Username command sets the username as required by the FTP Host.

#### ***To set the FTP username:***

At the Switched CDU: prompt, type **set ftp username**, followed by the FTP username and press **Enter**.

#### **Example**

The following command sets the FTP username to Guest:

```
Switched CDU: set ftp username guest<Enter>
```

### **Setting the FTP password:**

The Set FTP Password command sets the password as required by the FTP Host.

#### ***To set the FTP password:***

At the Switched CDU: prompt, type **set ftp password**, followed by the FTP password and press **Enter**.

#### **Example**

The following command sets the FTP password to Test1:

```
Switched CDU: set ftp password Test1<Enter>
```

### **Setting the filename to be uploaded:**

The Set FTP Filename command sets the filename of the firmware file to be uploaded.

#### ***To set the FTP filename:***

At the Switched CDU: prompt, type **set ftp filename**, followed by the firmware filename and press **Enter**.

#### **Example**

The following command sets the FTP filename to snb\_s50a.bin:

```
Switched CDU: set ftp filename swcdv-v60g.bin<Enter>
```

### **Setting the directory for the file to be uploaded:**

The Set FTP Directory command sets the directory for the firmware file to be uploaded.

#### ***To set the FTP directory:***

At the Switched CDU: prompt, type **set ftp directory**, followed by the directory and press **Enter**.

#### **Example**

The following command sets the FTP directory to ftp://Sentry:

```
Switched CDU: set ftp directory ftp://sentry<Enter>
```



## Enabling or disabling automatic updates:

The Set FTP Autoupdate command is used to enable or disable automatic firmware update support.

### *To enable or disable automatic updates:*

At the Switched CDU: prompt, type **set ftp autoupdate**, followed by **enabled** or **disabled** and press **Enter**.

## Setting the automatic update scheduled day:

The Set FTP Autoupdate Day command is used to set the day when automatic updates occur.

### *To set the automatic update day:*

At the Switched CDU: prompt, type **set ftp autoupdate day**, followed by a day of the week or **everyday** and press **Enter**.

### **Example**

The following command sets the automatic update day to Sunday:

```
Switched CDU: set ftp autoupdate day sunday<Enter>
```

## Setting the automatic update scheduled hour:

The Set FTP Autoupdate Hour command sets the hour of the day when automatic updates occur.

### *To set the automatic update hour:*

At the Switched CDU: prompt, type **set ftp autoupdate hour**, followed by an hour of the day and press **Enter**.

### **Examples**

The following command sets the automatic update hour to 12 AM:

```
Switched CDU: set ftp autoupdate hour 12am<Enter>
```

The following command sets the automatic update hour to 3 PM:

```
Switched CDU: set ftp autoupdate hour 3pm<Enter>
```

## Displaying FTP configuration information:

The Show FTP command displays all FTP configuration information.

- FTP Host IP address
- FTP Host username and password
- Firmware filepath and filename

### *To display FTP configuration information:*

At the Switched CDU: prompt, type **show ftp** and press **Enter**.

### **Example**

The following command displays the FTP configuration information:

```
Switched CDU: show ftp<Enter>
FTP Configuration
  Host:      10.1.2.100
  Username:  djones
  Password:  *****
  Directory: /firmware/7.0d
  Filename:  smcdv-v70d.bin
FTP Automatic Updates Configuration
  Automatic Updates:  Disabled
  Scheduled Day:      Everyday
  Scheduled Hour:     1 PM
```

## **SNTP Administration**

The PT45 supports the use of a network time service to provide a synchronized time reference.

### ***About Daylight Saving Time(DST)***

Support for DST is disabled by default. When enabled, the date and time are automatically adjusted forward one hour between the starting and ending dates and times (which can be configured).

---

**NOTE:** If Daylight Saving Time (DST) is enabled, all system time displays will be shown with the current DST start/end date/time settings.

---

The default time zone is set for the United States until at least 2015.

The time zone format is: **mo.w.d/h:m:s**, as follows:

**mo** = month from January to December (1-12)  
**w** = week number (1-4) or the last week (5)  
**d** = day of week from Sunday to Saturday (0-6)  
**h** = hour (0-23)  
**m** = minute (0-59)  
**s** = second (0-59)

### **Setting the SNTP server address:**

The Set SNTP command is used to set the primary and secondary SNTP server addresses.

#### ***To set the SNTP server address:***

At the Switched CDU: prompt, type **set sntp**, followed by **primary** or **secondary**, and the SNTP server IP address or hostname. Press **Enter**.

---

#### **NOTES:**

- The primary/secondary IP addresses contact the SNTP server; these addresses are populated with the external NTP pool time zones “2.servertech.pool.ntp.org” and “1.servertech.pool.ntp.org” as default for new PT45s that have not yet been time set.
  - Both IPv4 and IPv6 formats are accepted for primary/secondary IP address or hostname.
- 

### ***Examples***

The following command sets the primary SNTP server address to 204.152.184.72:

```
Switched CDU: set sntp primary 204.152.184.72<Enter>
```

The following command sets the secondary SNTP server address to cuckoo.nevada.edu:

```
Switched CDU: set sntp secondary cuckoo.nevada.edu<Enter>
```

### **Setting the local GMT offset (hours/minutes):**

The Set SNTP GMToffset command is used to set the offset from GMT for the date/time returned by SNTP.

The GMT offset supports all standard international time zones from -12:59 to +14:59. The GMT offset can be set in minutes to accommodate partial-hour time zones.

---

**NOTE:** The PT45 does not support automatic adjustment for Daylight Saving Time (DST).

---

#### ***To set the local GMT offset:***

At the Switched CDU: prompt, type **set sntp gmtoffset**, followed by the offset value, and press **Enter**.

### ***Examples***

The following command sets the local GMT offset to -12:

```
Switched CDU: set sntp gmtoffset -12<Enter>
```

## Displaying SNTP configuration information:

The Show SNTP command displays all SNTP configuration information.

### *To display SNTP configuration information*

At the Switched CDU: prompt, type **show sntp** and press **Enter**.

### **Example**

The following command displays the SNTP configuration information:

```
Switched CDU: show sntp <Enter>
Date/Time:      2013-04-13  15:21:18
Primary Host:   204.152.184.72
Secondary Host: 1.servertech.pool.ntp.org
Local GMT Offset: -8
Use DST:        Enabled
Start Date:     1st Wednesday in April
Start Time:     04:18:06
End Date:       1st Sunday in November
End Time:       02:00:00
```

## UPS Administration

### **Creating a UPS record:**

The Create UPS command adds a new UPS device to the PT45.

### *To create a UPS record:*

At the Switched CDU: prompt, type **create UPS** and press **Enter**.

At the prompt, type the corresponding number from the list of the UPS types and press **Enter**.

At the Host Name: prompt, type the UPS's IP address or hostname and press **Enter**.

---

**NOTE:** Both IPv4 and IPv6 formats are accepted for IP address or hostname.

---

### **Example**

The following command creates a UPS record for a Toshiba UPS with the hostname 'DC1Toshiba1':

```
Switched CDU: create ups<Enter>
UPS types:
 1 -- Generic <RFC1628>
 2 -- Liebert
 3 -- MGE
 4 -- Tripp Lite
 5 -- APC
 6 -- HP
 7 -- Minuteman
 8 -- Mitsubishi
 9 -- Powerware
10 -- Toshiba
11 -- Falcon Electric
Select type(1-11): 10<Enter>
Host/IP: DC1Toshiba1<Enter>
```

## Removing a UPS record:

The Remove UPS command removes a UPS record.

### *To remove a UPS record:*

At the Switched CDU: prompt, type **remove ups** and press **Enter**.

At the prompt, type the index number of the UPS to be removed and press **Enter**.

### *Example*

The following command removes the UPS record at index 3:

```
Switched CDU: remove ups<Enter>
 1  Type:    Liebert
    Host/IP: DC1Liebert1
 2  Type:    Powerware
    Host/IP: DC1Powerware1
 3  Type:    Toshiba
    Host/IP: DC1Toshiba1
Select UPS(1-8): 3<Enter>
```

## Changing the UPS type:

The Set UPS Type command is used to change the type of UPS for each UPS record.

### *To change a UPS record:*

At the Switched CDU: prompt, type **set ups type** and press **Enter**.

At the prompt, type the index number for the UPS record to be changed and press **Enter**.

At the prompt, type the corresponding number from the list of the UPS types and press **Enter**.

### *Example*

The following command changes UPS type for the record at index number 2 to 'MGE':

```
Switched CDU: set ups type<Enter>
 1  Type:    Liebert
    Host/IP: DC1Liebert1
 2  Type:    Powerware
    Host/IP: DC1Powerware1
Select UPS(1-8): 2<Enter>
UPS types:
 1 -- APC
 2 -- Liebert
 3 -- MGE
 4 -- Tripp Lite
 5 -- Generic (RFC1628)
 6 -- Hewlett Packard
 7 -- Minuteman
 8 -- Mitsubishi
 9 -- Powerware
10 -- Toshiba
11 -- Falcon Electric

Select type(1-11): 3<Enter>
```

## Changing the UPS host address:

The Set UPS Host command is used to change the IP address or hostname for each UPS record. Hostnames can be up to 60 characters long.

### *To change a UPS host address:*

At the Switched CDU: prompt, type **set ups host** and press **Enter**.

At the prompt, type the index number for the UPS record to be changed and press **Enter**.

At the prompt, type IP address or hostname for the UPS and press **Enter**.

### **Example**

The following command changes UPS hostname for the record at index number 2 to 'DC1MGE1':

```
Switched CDU: set ups host<Enter>
  1  Type:    Liebert
     Host/IP: DC1Liebert1
  2  Type:    MGE
     Host/IP: DC1Powerware1
Select UPS (1-8): 2<Enter>
Host/IP: DC1MGE1<Enter>
```

## Changing the UPS SNMP port:

With a UPS record configured, the PT45 sends data requests to the default UPS SNMP port number 161. This port number can be changed using the Set UPS Port command.

### *To change the UPS SNMP port:*

At the Switched CDU: prompt, type **set ups port** and press **Enter**.

At the prompt, type the index number for the UPS record to be changed and press **Enter**.

At the prompt, type the desired port number and press **Enter**.

### **Example**

The following command changes port for the UPS record at index number 1 to '162':

```
Switched CDU: set ups port<Enter>
UPS      UPS
Index   Type      Port
  1     Liebert   161
  2      MGE     161
Select UPS (1-8): 1<Enter>
Port: 162<Enter>
```

## Changing the UPS SNMP Get community string:

With a UPS record configured, the PT45 sends data requests to the UPS using the default Get community string of 'public'. This string can be changed using the Set UPS Port command.

---

**NOTE:** The GET community string configured on the PT45 must match the read-only community string on the UPS.

---

### *To change a UPS record:*

At the Switched CDU: prompt, type **set ups getcomm** and press **Enter**.

At the prompt, type the index number for the UPS record to be changed and press **Enter**.

At the prompt, type the Get community string for the UPS and press **Enter**.

### **Example**

The following command changes Get community string for the record at index number 2 to 'readonly':

```
Switched CDU: set ups getcomm<Enter>
UPS      UPS      Community
Index   Type      String
1       Liebert   public
2       MGE      public
Select UPS(1-8): 2<Enter>
Community String: readonly<Enter>
```

## Enabling/disabling UPS voltage polling:

With a UPS record configured, the PT45 by default enables voltage polling of the UPS. This feature can be enabled or disabled using the Set UPS VPoll command.

### *To enable/ disable UPS voltage polling:*

At the Switched CDU: prompt, type **set ups vpoll** and press **Enter**.

At the prompt, enter the index number for the UPS record to be changed and press **Enter**.

At the prompt, type **on** or **off**, and press **Enter**.

### **Example**

The following command disables voltage polling for the record at index number 2:

```
Switched CDU: set ups vpoll<Enter>
UPS      UPS      Voltage
Index   Type      Polling
1       Liebert   On
2       MGE      On
Select UPS(1-8): 2<Enter>
Voltage Polling: Off<Enter>
```

## Adding an infeed to a UPS:

The Set UPS AddInfeed command adds a logical association of an infeed to a UPS.

### *To add an infeed to a UPS:*

At the Switched CDU: prompt, type **set ups addinfeed** and press **Enter**.

At the prompt, enter the index number for the UPS record to be changed and press **Enter**.

At the prompt, type the absolute infeed ID of the desired infeed, and press **Enter**.

### **Example**

The following command associates infeed .aa to UPS record at index number 1:

```
Switched CDU: set ups addinfeed<Enter>
UPS      UPS      Infeed
Index   Type      IDs
1       Liebert
2       MGE      .AA
Select UPS(1-8): 1<Enter>
Infeed ID: .aa<Enter>
```

## Removing an infeed from a UPS:

The Set UPS DelInfeed command removes a logical association of an infeed from a UPS.

### *To remove an infeed from a UPS:*

At the Switched CDU: prompt, type **set ups delinfeed** and press **Enter**.

At the prompt, enter the index number for the UPS record to be changed and press **Enter**.

At the prompt, type the absolute infeed ID of the desired infeed, and press **Enter**.

### **Example**

The following command removes the association of infeed .aa from UPS record at index number 2:

```
Switched CDU: set ups addinfeed<Enter>
UPS      UPS      Infeed
Index   Type      IDs
1       Liebert   .AA
2       MGE      .AA
Select UPS(1-8): 2<Enter>
Infeed ID: .aa<Enter>
```

## Displaying UPS configuration:

The Show UPS command displays information about all UPS devices.

- UPS Type and Host/IP address
- UPS SNMP port and community string
- SNMP Objects OID values and expected return values

### *To display UPS configuration information:*

At the Switched CDU: prompt, type **show ups** and press **Enter**.

### **Example**

The following command displays UPS configuration information:

```
Switched CDU: show ups<Enter>
1  Type:      Liebert
   Host/IP:   DC1Liebert1
   Voltage Polling: ON
   SNMP Configuration
     Community String: public
     SNMP Port:      162
   SNMP Objects/Expected Values
     Voltage:        .1.3.6.1.2.1.33.1.4.4.1.2.1
     Utility Status: .1.3.6.1.2.1.33.1.4.1.0
     On Battery:     0x5
     On Utility:     0x3
More (Y/es N/o):
```

## Feature Administration

### Displaying activated special features:

The Show Features command displays all activated special features for the device.

### *To display activated special features:*

At the Switched CDU: prompt, type **show features** and press **Enter**.

### **Example**

The following command displays all activated special features:

```
Switched CDU: show features<Enter>
Activated Features:
  Smart Load Shedding
```

---

**NOTE:** A restart of the PT45 is required after activating new special features.

---

## Chapter 4: Advanced Operations

<b>SSL</b>	<b>89</b>
Enabling and Setting up SSL Support	89
SSL Technical Specifications	90
<b>SSH</b>	<b>91</b>
Enabling and Setting up SSH Support	91
SSH Technical Specifications	92
<b>SNMP/THRESHOLDS</b>	<b>93</b>
About SNMP Versions	93
Enabling and Setting Up SNMP v1/v2 Support	93
MIB, OID and Support	95
Enabling and Setting up SNMP Support	95
SNMP Traps	100
Configuring Traps	102
<b>LDAP</b>	<b>107</b>
Enabling and Setting up LDAP Support	108
Configuring LDAP Groups	112
LDAP Technical Specifications	116
<b>TACACS+</b>	<b>117</b>
Enabling and Setting up TACACS+ Support	117
Configuring TACACS+ Privilege Levels	119
TACACS+ Technical Specifications	122
<b>RADIUS</b>	<b>123</b>
Enabling and Setting Up RADIUS Support	123
Vendor-Specific Attributes (VSA):	126
<b>LOGGING</b>	<b>127</b>
Internal System Log	127
Syslog	127
Email	128
<b>UPLOAD/DOWNLOAD</b>	<b>131</b>
Integrated FTP Server	131
FTP Configuration Files	131
Upload/Download Process	132
<b>REMOTE SHUTDOWN</b>	<b>133</b>
Supported Operating Systems	134
Shutdown Agent Installation	134
Enabling and Setting up Remote Shutdown Support	135



Secure Socket Layers (SSL) enables secure Web sessions between a Remote Power Manager and a remote user. SSL provides two chief features designed to make TCP/IP (Internet) transmitted data more secure:

- Authentication – The connecting client is assured of the identity of the server.
- Encryption – All data transmitted between the client and the server is encrypted rendering any intercepted data unintelligible to any third party.

SSL uses the public-and-private key encryption system by RSA, which also requires the use of digital certificates. An SSL Certificate is an electronic file uniquely identifying individuals or websites and enables encrypted communication; SSL Certificates serve as a kind of digital passport or credential. The SSL certificate of the PT45 enables the client to verify the authenticity of the unit and to communicate with the unit securely via an encrypted session, protecting confidential information from interception and hacking.

### SSL Command Summary

Command	Description
Set SSL	Enables/disables SSL support
Set SSL Access	Sets SSL access as optional or required
Set SSL User Certificate	Enables/disables custom user certificates
Set SSL User Passphrase	Passphrase to control login access for user certificates

### Enabling and Setting up SSL Support

**NOTE:** You will need to restart the PT45 after setting or changing any SSL configurations.

#### Enabling or disabling SSL support:

The Set SSL command is used to enable or disable SSL support.

##### *To enable or disable SSL support:*

At the Switched CDU: prompt, type **set ssl**, followed by **enabled** or **disabled** and press **Enter**.

#### Setting SSL access level:

The Set SSL Access command is used to assign use of SSL as optional or required. The default access level is set to optional.

##### *To change the access level:*

At the Switched CDU: prompt, type **set ssl access**, followed **optional** or **required**, and press **Enter**.

#### **Example**

The following changes the access level to required:

```
Switched CDU: set ssl access required<Enter>
```

#### Enabling or disabling custom user certificates:

The Set SSL User Certificate command enables or disables uploading of custom user certificates.

##### *To enable or disable user certificates:*

At the Switched CDU: prompt, type **set ssl usercert**, followed by **enabled** or **disabled**, and press **Enter**.

#### Setting the custom user certificate passphrase:

The Set SSL User Passphrase command sets the user-defined passphrase for authentication of uploaded custom user certificates.

##### *To set the user certificate passphrase:*

At the Switched CDU: prompt, type **set ssl userpass** and press **Enter**. You will be prompted to provide the passphrase. Then press **Enter**.

**NOTE:** A restart of the unit is required after setting the user certificate passphrase.

## **SSL Technical Specifications**

Secure Socket Layer (SSL)

Transport Layer Security (TLS) version 1 (RFC 2246)

SSL/TLS-enabled HTTPS server (RFC 2818)

Self-Signed X.509 Certificate version 3 (RFC 2459)

Asymmetric Cryptography:

1024-bit RSA Key Exchange

Symmetric Cryptography Ciphers:

TLS\_RSA\_WITH\_AES\_256\_CBC\_SHA

TLS\_RSA\_WITH\_AES\_128\_CBC\_SHA

TLS\_RSA\_WITH\_3DES\_EDE\_CBC\_SHA

TLS\_RSA\_WITH\_DES\_CBC\_SHA

## SSH

Secure Shell (SSH) version 2 enables secure network terminal sessions between a Remote Power Manager and a remote user over insecure network. SSH provides an encrypted terminal sessions with strong authentication of both the server and client, using public-key cryptography and is typically used as a replacement for unencrypted Telnet. In addition to enabling secure network terminal sessions to the unit for configuration and power management, the SSH session can be used for secure Pass-Thru connections to attached devices.

SSH requires the configuration and use of a client agent on the client PC. There are many freeware, shareware or for-purchase SSH clients available. Two examples are the freeware client PuTTY and the for-purchase client SecureCRT® by VanDyke® Software. For configuration and use of these clients, please refer to the applicable software documentation.

### SSH Command Summary

Command	Description
Set SSH	Enables/disables SSH support
Set SSH AuthMethod	Enables/disables the SSH server authentication methods
Set SSH Port	Sets the SSH server port number

### Enabling and Setting up SSH Support

**NOTE:** You will need to restart the PT45 after setting or changing any SSH configurations.

#### Enabling or disabling SSH support:

The Set SSH command is used to enable or disable SSH support.

##### *To enable or disable SSH support:*

At the Switched CDU: prompt, type **set ssh**, followed by **enabled** or **disabled** and press **Enter**.

#### Changing the SSH server port:

With SSH support enabled, the SSH server watches and responds to requests on the default SSH port number 22. This port number can be changed using the Set SSH Port command.

##### *To change the SSH port:*

At the Switched CDU: prompt, type **set ssh port**, followed by the port number and press **Enter**.

#### **Example**

The following changes the SSH port number to 65535:

```
Switched CDU: set ssh port 65535<Enter>
```

#### Enabling or disabling SSH server authentication methods:

The Set SSH Authentication Method command is used to set the method of SSH server authentication. The SSH server supports two authentication methods for security and validation: Password and Keyboard-Interactive.

##### *To enable the SSH authentication methods:*

At the Switched CDU: prompt, type **set ssh authmethod**, followed by **password** or **kbint**, followed by **enabled** or **disabled**, and press **Enter**.

#### **Example**

The following example sets the SSH authentication method to keyboard-interactive:

```
Switched CDU: set ssh authmethod kbint enabled<Enter>
```

## **SSH Technical Specifications**

Secure Shell (SSH) version 2

Asymmetric Cryptography:

Diffie-Hellman DSA/DSS 512-1024 (random) bits per NIST specification

Symmetric Cryptography:

AES256-CBC      RIJNDael256-CBC      3DES-192-CBC

AES192-CBC      RIJNDael192-CBC

AES128-CBC      RIJNDael128-CBC

Message Integrity:

HMAC-SHA1-160

HMAC-MD5-128

Authentication:

Username/Password

Session Channel Break Extension (for RS232 Break)

## SNMP/Thresholds

The PT45 supports the Simple Network Management Protocol (SNMP). This allows network management systems to use SNMP requests to retrieve information and control power for the individual outlets.

The unit includes an SNMP v2c agent supporting standard MIB I and MIB II objects. A private enterprise MIB extension (Sentry3 MIB) is also supported to provide remote power control.

**NOTE:** The default for SNMP support is **Enabled**. When Server Technology products are shipped, the default SNMP configuration for the GET community string is set to “**public**” and the SET community string is left **blank**. You will need to restart the PT45 after enabling or disabling SNMP support

### About SNMP Versions

The firmware supports SNMP versions 1, 2, and 3.

SNMP version 3 supports authentication and encryption on a per user basis. Authentication types are None and MD5. Encryption types are None and DES. If you use authentication, you must use encryption.

Two SNMPv3 users are supported: one user with read-write (RW) access, and one user with read-only (RO) access. Both users have the same configuration parameters, and you can configure each user independently.

SNMPv2 and SNMPv3 can be enabled or disabled independently. You can have SNMPv2 and/or SNMPv3, or none.

#### SNMP CLI Commands:

- All SNMP v3 specific configuration settings use the CLI command SET SNMP V3.
- All SNMP v1/v2 specific configuration settings use the CLI command SET SNMP V2.
- All SNMP configuration settings common to any SNMP version use the CLI command SET SNMP.

#### NOTES:

- If you use SNMP v1 or SNMP v2, all SET SNMP CLI commands (and the SHOW command) require the “V2” keyword.
- SNMP v1/v2 CLI commands are documented immediately below in this section showing the required “V2” keyword. All CLI commands that follow the SNMP v1/v2 section in this manual assume SNMP v3.

### SNMP v1/v2 Command Summary

Command	Description
Set SNMP IP Restrict	Allows SNMP Get and Set requests only from defined trap destinations
Set SNMP V2	Enables or disables SNMP v1/v2 support
Set SNMP V2 Getcomm	Sets the Get community string
Set SNMP V2 Setcomm	Sets the Set community string
Show SNMP	Displays all SNMP configuration information

### Enabling and Setting Up SNMP v1/v2 Support

SNMP v1/v2 support must be enabled and configured for access to Sentry3 MIB objects and generation of all Sentry3 traps.

#### Enabling/disabling SNMP support:

The SNMP Set command is used to enable or disable SNMP v1/v2 support.

#### To enable SNMP v1/v2 support:

At the Switched CDU: prompt, type **set snmp v2**, followed by **enabled** or **disabled** and press **Enter**.

**NOTE:** A restart of the PT45 is required after enabling or disabling SNMP support.

## Setting the Get/Set community strings:

---

**NOTE:** The default for SNMP support is **Enabled**. When Server Technology products are shipped, the default SNMP configuration for the Get community string is set to “**public**” and the Set community string is left **blank**.

---

The PT45 supports two SNMP community strings (Get and Set) that provide varying levels of access to objects defined in the Sentry3 MIB. Valid community strings are 1 to 24 characters.

### *Set Community String:*

The Setcomm string provides read-write access to sentry3 MIB objects. The default Setcomm string is blank.

### *To set the Setcomm community string:*

At the Switched CDU: prompt, type **set snmp v2 setcomm**, followed by the string, and press **Enter**.

### *Get Community String:*

The Getcomm string provides read-only access to sentry3 MIB objects. The default Getcomm string is public.

### *To set the Getcomm community string:*

At the Switched CDU: prompt, type **set snmp v2 getcomm**, followed by the string, and press **Enter**.

## Displaying SNMP v1/v2 configuration information:

The Show SNMP V2 command displays all SNMP v1/v2 configuration information, including:

- SNMP support status
- SNMP community strings
- Trap timer value
- Trap destinations (both IPv4 and IPv6 formats can be displayed.)

### *To display SNMP v1/v2 configuration information:*

At the Switched CDU: prompt, type **show snmp v2** and press **Enter**.

### **Example**

The following command displays the SNMP configuration information:

```
Switched CDU: show snmp v2<Enter>
SNMP Configuration
  SNMPv2 Agent:                Enabled
    GET Community <RO>:        public
    SET Community <RW>:        <undefined>
    TRAP Community:            trap

  SNMPv3 Agent:                Disabled

  Engine ID                    800006B6020000000000000000000000FFFF0A010249
  RW Username:                 <undefined>
  RW Auth Type:                None <password not set>
  RW Privacy Type:             None <password not set>

  RO Username:                 <undefined>
  RO Auth Type:                None <password not set>
  RW Privacy Type:             None <password not set>

  Trap Username                <undefined>
  Trap Destination 1:          <undefined>
  Trap Destination 2:          <undefined>
  Trap format:                 v3

  IP Restrictions:             No Restrictions
  Error Trap Repeat Time:      60 second<s>

  SysName:                     Sentry3_524640
  SysLocation:                 No Location
  SysContact:                  No Contact

Command successful
```

## SNMP v3 Command Summary

Command	Description
Set SNMP IP Restrict	Allows SNMP Get and Set requests from defined trap destinations only
Set SNMP V3	Enables or disables SNMP v3 support
Set SNMP V3 RO Username	Sets the SNMP V3 read-only username.
Set SNMP V3 RO Auth Type	Sets the SNMP V3 read-only authentication type
Set SNMP V3 RO Auth Password	Sets the SNMP V3 read-only authentication password
Set SNMP V3 RO Priv Type	Sets the SNMP V3 read-only privacy type
Set SNMP V3 RO Priv Password	Sets the SNMP V3 ready-only privacy password
Set SNMP V3 RW Username	Sets the SNMP V3 read-write username
Set SNMP V3 RW Auth Type	Sets the SNMP V3 read-write authentication type
Set SNMP V3 RW Auth Password	Sets the SNMP V3 read-write authentication password
Set SNMP V3 Trap Username	Sets the SNMP V3 trap username for display on SNMP activity logs
Set SNMP V3 RW Priv Type	Sets the SNMP V3 read-write privacy type
Set SNMP V3 RW Priv Password	Sets the SNMP V3 ready-write privacy password
Show SNMP	Displays all SNMP configuration information

## MIB, OID and Support

The PT45 SNMP MIB and OID are available on the Server Technology website:

<ftp://ftp.servertech.com/pub/SNMP/sentry3>

Technical support is available 8:00AM to 5:00 PM Pacific Time, Monday-Friday.

For SNMP Support, email: [mibmaster@servertech.com](mailto:mibmaster@servertech.com)

## Enabling and Setting up SNMP Support

SNMP support must be enabled and configured for access to Sentry3 MIB objects and generation of all Sentry3 traps.

### Enabling/disabling SNMP support:

The SNMP command is used to enable or disable SNMP support.

#### *To enable SNMP support:*

At the Switched CDU: prompt, type **set snmp v3**, followed by **enabled** or **disabled** and press **Enter**.

---

**NOTE:** A restart of the PT45 is required after enabling or disabling SNMP support.

---

### SNMPv3 Engine ID:

The local engine ID is the unique identifier for the SNMPv3 engine and is displayed for viewing.

### Setting the SNMP v3 read-only (RO) username:

The Set SNMP RO Username command sets the read-only username for SNMP v3. A valid username can be set to any value between 1-32 characters.

#### *To set the RO username:*

At the Switched CDU: prompt, type **set snmp v3 rousername**, and press **Enter**.

---

**NOTE:** You can set a blank username but doing so will clear the string and disallow any read-only user access.

---

### Setting the SNMP v3 read-only (RO) authentication type:

The Set SNMP RO Auth Type command sets the SNMP v3 RO authentication type.

#### *To set the RO authentication type:*

At the Switched CDU: prompt, type **set snmp v3 roauthtype**, followed by **none** or **md5**, and press **Enter**.

### Setting the SNMP v3 read-only (RO) authentication password:

The Set SNMP RO Auth Password command sets the SNMP v3 RO authentication password. A valid authentication password can be set to any value between 1-40 characters. A blank password will clear the string.

#### *To set the RO authentication password:*

At the Switched CDU: prompt, type **set snmp v3 roauthpass**, and press **Enter**.

### Setting the SNMP v3 read-only (RO) privacy type :

The Set SNMP RO Priv Type command sets the SNMP v3 RO privacy type.

#### *To set the RO privacy type:*

At the Switched CDU: prompt, type **set snmp v3 roprivtype**, followed by **none** or **des**, and press **Enter**.

### Setting the SNMP v3 read-only (RO) privacy password:

The Set SNMP RO Priv Password command sets the SNMP v3 RO privacy password. A valid privacy password can be set to any value between 1-32 characters. A blank password will clear the string

#### *To set the RO privacy password:*

At the Switched CDU: prompt, type **set snmp v3 roprivpass**, and press **Enter**

### Setting the SNMP v3 read-write (RW) username :

The Set SNMP RW Username command sets the read-write username for SNMP v3. A valid username can be set to any value between 1-32 characters.

To set the RW username:

At the Switched CDU: prompt, type **set snmpv3 rwusername**, and press **Enter**.

---

**NOTE:** You can set a blank username but doing so will clear the string and disallow any read-write user access.

---

### Setting the SNMP v3 read-write (RW) authentication type :

The Set SNMP RW Auth Type command sets the SNMP v3 RW authentication type.

#### *To set the RW authentication type:*

At the Switched CDU: prompt, type **set snmp v3 rwauthtype**, followed by **none** or **md5**, and press **Enter**.

### Setting the SNMP v3 read-write (RW) authentication password:

The Set SNMP RW Auth Password command sets the SNMP v3 RW authentication password. A valid authentication password can be set to any value between 1-40 characters. A blank password will clear the string

#### *To set the RW authentication password:*

At the Switched CDU: prompt, type **set snmp v3 rwauthpass**, and press **Enter**.

### Setting the SNMP v3 read-write (RW) privacy type :

The Set SNMP RW Priv Type command sets the SNMP v3 RW privacy type. A valid password can be set to any value between 1-40 characters.

#### *To set the RW privacy type:*

At the Switched CDU: prompt, type **set snmp v3 rwprivtype**, followed by **none** or **des**, and press **Enter**.

### Setting the SNMP v3 read-write (RW) privacy password:

The Set SNMP RW Priv Password command sets the SNMP v3 RW privacy password. A valid privacy password can be set to any value between 1-32 characters. A blank password will clear the string

#### *To set the RW privacy password:*

At the Switched CDU: prompt, type **set snmp v3 rwprivpass**, and press **Enter**.



### Setting the SNMP v3 trap username:

The Set SNMP Trap Username command sets an optional username for display on SNMP activity logs to identify user actions.

At the Switched CDU: prompt, type **set snmp v3 trapusername**, and press **Enter**. The trap username can be 1-31 alphanumeric characters; spaces are allowed; and the name is case sensitive.

### Setting the error trap repeat timer:

The Set SNMP Traptime command sets the timer period between repeated error condition traps. The valid range is 1 to 65535 (in seconds). The default is 60 seconds.

#### *To set the error trap repeat timer:*

At the Switched CDU: prompt, type **set snmp traptime**, followed by the timer period, and press **Enter**.

#### **Example**

The following sets the timer period to 180 seconds:

```
Switched PDU: set snmp traptime 180<Enter>
```

### Setting IP Restrictions:

The Set SNMP IP Restrictions command supports SNMP Manager Get and Set requests to only be allowed from the IP address of the defined trap destinations.

#### *To set SNMP IP restrictions:*

At the Switched CDU: prompt, type **set snmp iprestrict trapdests** and press **Enter**.

#### *To remove SNMP IP restrictions:*

At the Switched CDU: prompt, type **set snmp iprestrict none** and press **Enter**.

### Setting trap destinations:

The Set SNMP Trapdest1 and Trapdest2 commands are used to set the IP addresses or hostname of SNMP management stations receiving all traps. The PT45 supports a maximum of two trap destinations; one must be defined to enable trap generation.

#### *To set the trap destination:*

At the Switched CDU: prompt, type **set snmp, trapdest1** or **trapdest2**, the Ipaddress or hostname and press **Enter**.

#### **Examples**

The following sets the trap destination 1 to 64.42.31.208:

```
Switched CDU: set snmp trapdest1 64.42.31.208<Enter>
```

The following sets the trap destination 2 to snmp.servertech.com:

```
Switched CDU: set snmp trapdest2 snmp.servertech.com<Enter>
```

#### *To reset the trap destination:*

At the Switched CDU: prompt, type **set snmp, trapdest1** or **trapdest2, 0.0.0.0** and press **Enter**.

### Setting the Get/Set community strings:

The PT45 supports two SNMP community strings that provide varying levels of access to objects defined in the Sentry3 MIB.

Community strings can be 1 to 24 characters.

#### *Setcomm:*

The Setcomm string provides read-write access to sentry3 MIB objects. The default Setcomm string is blank.

#### *To set the Setcomm community string:*

At the Switched CDU: prompt, type **set snmp setcomm**, followed by the string and press **Enter**.

#### *Getcomm:*

The Getcomm string provides read-only access to sentry3 MIB objects. The default Getcomm string is “public”.

#### *To set the Getcomm community string:*

At the Switched CDU: prompt, type **set snmp getcomm**, followed by the string and press **Enter**.

### Setting the SNMP SysName:

The Set SNMP SysName command is used to set the SNMP MIB-II SysName object.

#### *To set the SysName object:*

At the Switched CDU: prompt, type **set snmp sysname**, followed by the object name and press **Enter**.

### Setting the SNMP SysLocation:

The Set SNMP SysLocation command is used to set the SNMP MIB-II SysLocation object.

#### *To set the SysLocation object:*

At the Switched CDU: prompt, type **set snmp syslocation**, followed by the object location and press **Enter**.

### Setting the SNMP SysContact:

The Set SNMP SysContact command is used to set the SNMP MIB-II SysContact object.

#### *To set the SysContact object:*

At the Switched CDU: prompt, type **set snmp syscontact**, followed by the object contact and press **Enter**.



## SNMP Traps

The PT45 supports five types of SNMP traps. Traps are enabled at the Tower (T), Infeed (I), outlet (O), Environmental Monitor (E) or sensor (S) level.

### Trap Summary

Name	Level(s)	Description
Status	T, I, O, E, S	Operational status change
Change	O	Control status change
Load	I	Input load out of limit
Temp	S	Temperature is out of range
Humid	S	Relative Humidity is out of range

All traps include the location of the PT45 as defined with the Set Location command.

### Status trap

A Status trap is generated when an error condition occurs on a tower, infeed, Environmental Monitor or individual sensor. Status traps include the reported status, the location of the PT45, and identifier/name of the affected tower, infeed, outlet, environmental monitor, or sensor.

Any error state generates a Status trap and triggers the trap timer. A new trap is generated at the end of every timer period until the Status returns to a non-error status. All status traps are enabled by default.

### Tower Status traps

Status	Error	Description
Normal		Tower is working correctly
NoComm	x	Communication to the tower has been lost

### Infeed Status traps

Status	Error	Description
On		Infeed is on
OffError	x	Infeed should be on but no current is sensed at the infeed
NoComm	x	Communication to the infeed has been lost

### Outlet Status traps

Status	Error	Description
On		Outlet is on
Off		Outlet is off
OnWait		Outlet Status in transition
OffWait		Outlet Status in transition
OnError	x	Outlet should be off but current is sensed at the outlet
OffError	x	Outlet should be on but no current is sensed at the outlet
OffFuse	x	Outlet should be on but a blown fuse has been detected
NoComm	x	Communication to the outlet has been lost

### Environmental Monitor Status traps

Status	Error	Description
Normal		Environmental Monitor is working correctly
NoComm	x	Communication to the Environmental Monitor has been lost

## Temperature/Humidity Sensor Status traps

Status	Error	Description
Found		The sensor has been detected
NotFound		No sensor has been detected
Lost	x	Sensor initially detected but communication to the sensor has been lost
NoComm	x	Communication to the sensor has been lost

**NOTE:** Traps are generated according to a hierarchical architecture, for example, if a Tower Status enters a trap condition, only the Tower Status trap will be generated. Infeed, Outlet, Environmental Monitor or Sensor Status and Temp and Humid traps will be suppressed until the Tower Status returns to Normal.

## Change trap

The Change trap is generated for all outlet status changes between any on/off conditions. Change traps include the outlet status, Location of the PT45, and identifier/name of the affected outlet. For descriptions of the outlet status types, please refer to the previous table.

## Load Trap

The Load trap is generated whenever the total input load on an infeed exceeds a preset threshold. Load traps include the reported input load, load status, Location of the PT45, and identifier/name of the affected infeed. Any error state generates a Load trap and triggers the trap timer. A new trap is generated at the end of every timer period until the Load returns to a non-error status.

## Load traps

Status	Error	Description
Normal		Infeed is on and within preset thresholds
NotOn		Infeed is off
Reading		Non-error state – Load status currently being read
LoadHigh	x	Infeed current load exceeds preset threshold
OverLoad	x	Infeed current load exceeds the measurable range for the infeed
ReadError	x	Unable to read Load status
NoComm	x	Communication to the infeed has been lost

## Temp Trap

The Temp trap is generated whenever the temperature on a temperature/humidity sensor is beyond preset thresholds. Temp traps include the reported temperature, temp status, location of the PT45, and identifier/name of the affected sensor. Any error state generates a Temp trap and triggers the trap timer. A new trap is generated at the end of every timer period until the Temp returns to a non-error status.

## Temp traps

Status	Error	Description
Normal		The sensor is working correctly and the temperature is within preset thresholds
NotFound		No sensor has been detected
Reading		Temp status currently being read
TempLow	x	Temperature at the sensor below preset low threshold
TempHigh	x	Temperature at the sensor exceeds preset high threshold
ReadError	x	Unable to read Temp status
Lost	x	Sensor initially detected but communication to the sensor has been lost
NoComm	x	Communication to the sensor has been lost

## **Humidity Trap**

The Humidity trap is generated whenever the humidity on a temperature/humidity sensor is beyond preset thresholds. Humidity traps include the reported relative humidity, humidity status, location of the PT45, and identifier/name of the affected sensor. Any error state generates a Humidity trap and triggers the trap timer. A new trap is generated at the end of every timer period until the Humidity returns to a non-error status.

### **Humidity traps**

<b>Status</b>	<b>Error</b>	<b>Description</b>
Normal		The sensor is working correctly and the relative humidity is within preset thresholds
NotFound		No sensor has been detected
Reading		Humidity status currently being read
HumidLow	x	Relative humidity at the sensor below preset low threshold
HumidHigh	x	Relative humidity at the sensor exceeds preset high threshold
ReadError	x	Unable to read Humidity status
Lost	x	Sensor initially detected but communication to the sensor has been lost
NoComm	x	Communication to the sensor has been lost

## **Configuring Traps**

### **SNMP Trap Command Summary**

<b>Command</b>	<b>Description</b>
Set Trap Tower Status	Enables or disables the Tower Status trap
Set Trap Infeed Status	Enables or disables the Infeed Status trap off
Set Trap Infeed Load	Enables or disables the Infeed Load trap
Set Trap Infeed HighThresh	Sets the Infeed Load trap high limit
Set Trap Outlet Change	Enables or disables the Outlet Change trap
Set Trap Outlet Status	Enables or disables the Outlet Status trap
Set Trap EM Status	Enables or disables the Environmental Monitor Status trap
Set Trap THS Status	Enables or disables a temperature/humidity sensor Status trap
Set Trap THS Temp	Enables or disables a temperature/humidity sensor Temp trap
Set Trap THS Temp Delta	Sets temperature recovery delta
Set Trap THS Temphigh	Sets a temperature/humidity sensor Temp trap high limit
Set Trap THS Templow	Sets a temperature/humidity sensor Temp trap low limit
Set Trap THS Humid	Enables or disables a temperature/humidity sensor Humid trap
Set Trap THS Humidhigh	Sets a temperature/humidity sensor Humid trap high limit
Set Trap THS Humidlow	Sets a temperature/humidity sensor Humid trap low limit
Show Traps	Displays trap configurations

## Enabling or Disabling a Status trap:

The Set Trap ... Status command is used to enable or disable Status traps for a Tower, Infeed or Outlet.

### *To Enable or Disable a Status trap:*

At the Switched CDU: prompt, type **set trap (tower, infeed, outlet, em or ths) status**, followed by the tower, infeed or outlet name, and **on** or **off**. Press **Enter**, or:

Type **set trap (tower, infeed, outlet, em or ths) Status all**, followed by **on** or **off** and press **Enter**.

### **Examples**

The following command enables the Status trap for the first tower, using the tower's absolute name:

```
Switched CDU: set trap tower status .a on<Enter>
```

The following command enables the Status trap for the tower named Florida\_HQ\_1:

```
Switched CDU: set trap tower status Florida_HQ_1 on<Enter>
```

---

**NOTE:** Enabling lower hierarchical traps automatically enables traps of higher hierarchical value, for example, enabling an Outlet Status trap automatically enables the Infeed and Tower Status traps for that outlet. Conversely, if a Tower Status trap is disabled, all associated Infeed Status and Load and Outlet Status traps will be disabled..

---

## Enabling or Disabling a Load trap:

The Set Trap Infeed Load command is used to enable or disable an Infeed Load trap.

### *To Enable or Disable a Load trap:*

At the Switched CDU: prompt, type **set trap infeed load**, followed by the infeed name, and **on** or **off**. Press **Enter**, or

Type **set trap infeed load all**, followed by **on** or **off** and press **Enter**.

### **Examples**

The following command enables the Load trap for second infeed on the first tower, using the absolute name of the infeed.

```
Switched CDU: set trap infeed load .AB on<Enter>
```

The following command disables the Load trap for all infeeds:

```
Switched CDU: set trap infeed load all off<Enter>
```

---

**NOTE:** Enabling lower hierarchical traps automatically enables traps of higher hierarchical value: i.e. enabling an Infeed Load trap automatically enables the Infeed and Tower Status traps for that infeed.

---

## Setting the Infeed Load limit:

The Set Trap Infeed Loadhigh command is used to set the upper load limits for an input feed.

### *To set the infeed load limit:*

At the Switched CDU: prompt, type **set trap infeed loadhigh**, followed by the infeed name, and a value from 0 to 255 in amperes. Press **Enter**.

### **Example**

The following command sets the infeed load limit for the second infeed on the first tower to 25 amperes, using the absolute name of the infeed:

```
Switched CDU: set trap infeed loadhigh .ab 25<Enter>
```

### Enabling or Disabling a Change trap:

The Set Trap Outlet Change command is used to enable or disable an Outlet Change trap.

#### *To Enable or Disable a Change trap:*

At the Switched CDU: prompt, type **set trap outlet change**, followed by the outlet name and **on** or **off**. Press **Enter**, or Type **set trap outlet change all**, followed by **on** or **off** and press **Enter**.

#### **Example**

The following command enables the Change trap for the third outlet on the first infeed of the second tower, using the outlet's absolute name:

```
Switched CDU: set trap outlet change .ba3 on<Enter>
```

#### *To Enable or Disable the Temp trap:*

At the Switched CDU: prompt, type **set trap ths temp**, followed by the sensor name and **on** or **off**. Press **Enter**.

#### **Example**

The following command enables the Temp trap for the first temperature-humidity sensor:

```
Switched CDU: set trap ths temp .a1 on<Enter>
```

### Setting the Temperature sensor threshold limits:

The Set Trap THS Templo and Set Trap THS Temphigh commands are used to set the lower and upper threshold limits for the Temperature sensor.

#### *To set the Temperature threshold limits:*

At the Switched CDU: prompt, type **set trap ths, templo** or **temphigh**, followed by the sensor name and a value from 0 to 123 in degrees Celsius. Press **Enter**.

#### **Example**

The following command sets the second temperature high threshold limit to 95:

```
Switched CDU: set trap ths temphigh .a2 95<Enter>
```

### Configuring Temperature Recovery Delta (Hysteresis):

The Temperature Recovery Delta command allows configuration of the number of degrees of change needed to recover from a temperature alarm. For more information, see the Web Interface section, "Temperature Recovery Delta".

#### *To configure the temperature recovery delta:*

At the Switched CDU: prompt, type **set event temp tempdelta**, followed by the sensor name, the number of degrees for the recovery delta, and press **Enter**. Valid range is 0-30 C or 0-54 F.

#### **Example**

The following command configures the recovery delta at 2 degrees Fahrenheit for temperature/humidity sensor .A1:

```
Switched CDU: event temp tempdelta temp_humid_sensor_A1 2<Enter>
```

#### *To configure the humidity recovery delta:*

At the Switched CDU: prompt, type **set trap ths humiddelta**, followed by the sensor name, the percentage for the recovery delta, and press **Enter**. Valid range is 0-20%.

#### **Example**

The following command configures the recovery delta at 2 relative humidity for temperature/humidity sensor .A1:

```
Switched CDU: set trap ths humiddelta temp_humid_sensor_A1 2<Enter>
```



### **Enabling or Disabling the Humid trap:**

The Set Trap THS Humid command is used to enable or disable the Humid trap.

#### ***To Enable or Disable the Humid trap:***

At the Switched CDU: prompt, type **set trap ths humid**, followed by the sensor name and **on** or **off**. Press **Enter**.

#### ***Example***

The following command enables the Humid trap for the first temperature-humidity sensor:

```
Switched CDU: set traps ths humid .a1 on<Enter>
```

### **Setting the Humidity sensor threshold limits:**

The Set Trap THS Humidlow and Set Trap THS Humidhigh commands are used to set the lower and upper threshold limits for the Humidity sensor.

#### ***To set the Humidity threshold limits:***

At the Switched CDU: prompt, type **set trap ths, humidlow** or **humidhigh**, followed by the sensor name and a value from 0 to 100 in percentage of relative humidity. Press **Enter**.

#### ***Example***

The following command sets the first humidity sensor low threshold limit to 5:

```
Switched CDU: set trap ths humidlow .a1 5<Enter>
```

## Displaying trap configuration information:

The Show Traps command displays information about all traps.

### To display trap information:

At the Switched CDU: prompt, type **show traps** and press **Enter**.

### Example

The following command requests trap configuration information:

```
Switched CDU: show traps <Enter>
Tower trap configuration:
  Tower      Tower      Status
  ID         Name         Trap
  .A         Florida_HQ_1  ON
  .B         Florida_HQ_2  ON
More (Y/es N/o): y
Input feed trap configuration:
  Input      Input      Status   Load   High
  Feed ID    Feed Name   Trap     Trap   Load
  .AA        HQ_1_Infeed_A  ON       ON     255 A
  .BA        HQ_2_Infeed_A  ON       ON     255 A
More (Y/es N/o): y
Outlet trap configuration:
  Outlet      Outlet      Stats    Change
  ID          Name        Trap     Trap
  .AA1        DataServer_1  ON       OFF
  .AA2        WebServer_1  ON       OFF
  .AA3        FileServer_1  ON       OFF
  .AA4                            ON       OFF
  .AA5                            ON       OFF
  .AA6                            ON       OFF
  .AA7                            ON       OFF
  .AA8                            ON       OFF
  .AB1                            ON       OFF
  .AB2                            ON       OFF
  .AB3                            ON       OFF
  .AB4                            ON       OFF
  .AB5                            ON       OFF
  .AB6                            ON       OFF
  .AB7                            ON       OFF
  .AB8                            ON       OFF
More (Y/es N/o): y
Environmental Monitor .A trap configuration:
Name: Florida_HQ_1
Status Trap: ON
Temperature/Humidity Sensor .A1      Temperature/Humidity Sensor .A2
  Name: Temp_Humid_Sensor_A1          Name: T/H2_Florida_HQ_1
  Status Trap: ON                      Status Trap: ON
  Temp Trap: ON                         Temp Trap: ON
    Low: 31 Deg.F                       Low: 32 Deg.F
    High: 253 Deg.F                      High: 253 Deg.F
    Delta: 5 Deg.F                       Delta: 2 Deg.F
  Humid Trap: ON                        Humid Trap: ON
    Low: 5 % RH                          Low: 0 % RH
    High: 100 % RH                       High: 100 % RH
```

## LDAP

The PT45 supports Lightweight Directory Access Protocol (LDAP) Version 3. This support enables authentication with LDAP servers; user accounts do not need to be individually created locally on each unit.

This allows administrators to pre-define and configure (in each PT45 and in the LDAP server) a set of necessary LDAP Groups, and access rights for each. User's access rights can then be assigned or revoked simply by making the user a member of one-or-more pre-defined PT45 LDAP Groups. User accounts can be added, deleted, or changed in the LDAP server without any changes needed on individual PT45 units.

LDAP support has been tested in the following environments:

- Microsoft Active Directory (MSAD)
- Novell eDirectory (eDir)
- OpenLDAP

### LDAP Command Summary

Command	Description
Add GrouptoLDAP	Grants an LDAP group access to one or more groups
Add OutlettoLDAP	Grants an LDAP group access to one or more outlets
Add PorttoLDAP	Grants an LDAP group access to one or more serial ports
Create LDAPGroup	Adds an LDAP group name
Delete GroupfromLDAP	Removes access to one or more groups for an LDAP group
Delete OutlettoLDAP	Removes access to one or more outlets for an LDAP group
Delete PortfromLDAP	Removes access to one or more serial ports for an LDAP group
List LDAPGroup	Displays all accessible outlet/groups/ports for an LDAP group
List LDAPGroups	Displays privilege levels for all LDAP groups
Ping	Verifies proper DNS configuration by name resolution
Remove LDAPGroup	Deletes an LDAP group name
Set Authorder	Specifies the authentication order for each new session attempt
Set DNS	Sets the IP address of the Domain Name server
Set LDAP Bind	Specifies the LDAP bind request password type
Set LDAP BindDN	Specifies the user account Distinguished Name (DN) for binds
Set LDAP BindPW	Specifies the user account password for binds
Set LDAP GroupAttr	Specifies the user class distinguished name (DN) or names of groups in which a user is a member
Set LDAP GroupType	Specifies the data type for the Set LDAP GroupAttr command
Set LDAP Host	Sets the IP address or hostname of the Directory Services server
Set LDAP Port	Sets the LDAP server port number
Set LDAP UserBaseDN	Sets the base distinguished name (DN) for the username search at login
Set LDAP UserFilter	Sets the filter used for the username search at login
Set LDAP UseTLS	Enables/disables LDAP over TLS/SSL support
Set LDAP	Enables/disables LDAP support
Set LDAPGroup Access	Sets the access level for an LDAP group
Set LDAPGroup Envmon	Grants or removes privileges to view input and environmental monitoring status
Show LDAP	Displays LDAP configurations
Show Network	Displays network configuration information

## **Enabling and Setting up LDAP Support**

There are a few configuration requirements for properly enabling and setting up LDAP support. Below is an overview of the minimum requirements.

Directory Services server configuration requirements:

1. Define at least one LDAP group.
2. Assign users to that LDAP group.

PT45 configuration requirements:

1. Enable LDAP support.
2. Define the IP address and domain component of at least one Directory Services server.
3. Set the LDAP bind request method being utilized by the Directory Services server.
4. Define the IP address of at least one DNS server.
5. Test DNS server configuration using Ping support.
6. Define at least one LDAP group and assign access rights for that group.

---

**NOTE:** LDAP group names on the Directory Service server and the PT45 must match..

---

### **Enabling and disabling LDAP support:**

The Set LDAP command is used to enable or disable LDAP support.

#### ***To enable or disable LDAP support:***

At the Switched CDU: prompt, type **set ldap**, followed by **enabled** or **disabled** and press **Enter**.

### **Setting the LDAP host address:**

The Set LDAP Host command sets the TCP/IP address of the Directory Services server.

---

**NOTE:** Both IPv4 and IPv6 formats are accepted for hostname.

---

#### ***To set the LDAP host address:***

At the Switched CDU: prompt, type **set ldap**, followed by **host1** or **host2** and the Directory Services server's IP address or hostname. Press **Enter**.

#### ***Examples***

The following command sets the primary Directory Services server IP address to 98.76.54.32:

```
Switched CDU: set ldap host1 98.76.54.32<Enter>
```

The following command sets the secondary Directory Services server hostname to ldap.servertech.com:

```
Switched CDU: set ldap host2 ldap.servertech.com<Enter>
```

### **Changing the LDAP server port:**

The Set LDAP Port command sets the port to which the PT45 sends LDAP requests to on the previously defined LDAP server. The default port is 389.

#### ***To change the LDAP server port:***

At the Switched CDU: prompt, type **set ldap port**, followed by the port number and press **Enter**.

#### ***Example***

The following command sets the LDAP server port number to 8888:

```
Switched CDU: set ldap port 8888<Enter>
```

### **Enabling and disabling LDAP over TLS/SSL support:**

The Set LDAP UseTLS command is used to enable or disable LDAP over TLS/SSL support.

#### ***To enable or disable LDAP over TLS/SSL support:***

At the Switched CDU: prompt, type **set ldap usetls**, followed by **yes** or **no** and press **Enter**.

---

**NOTE:** If LDAP Over TLS/SSL is enabled, MD5 binding is disabled.

---

## Setting the LDAP bind password type:

The Set LDAP Bind command sets the password type used in the bind requests. The PT45 supports two standard LDAP bind methods: Simple and MD5.

The Simple method uses unencrypted delivery of a username-password over the network to the Active Directory server for authentication.

The MD5 digest method provides much stronger protection using 1-way hash encoding that never transmits the username-password over the network.

---

**NOTE:** Windows 2000 supports only Simple binding. Windows 2003 supports both Simple binding and MD5 binding.

---

### *To set the bind password type:*

At the Switched CDU: prompt, type **set ldap bind**, followed by **simple** and press **Enter**.

---

**NOTE:** If MD5 binding is enabled, LDAP over TLS/SSL is disabled.

---

## Setting the search bind Distinguished Name (DN):

The Set LDAP BindDN command is used to set the distinguished name (DN) for user accounts to bind with. This is required for directory services that do not support anonymous binds. This field is used ONLY with Simple Binds. Maximum string length is 124 characters.

---

**NOTE:** If left blank, then an anonymous bind will be attempted. This field is used only with Simple binds.

---

### *To set the search bind DN:*

At the Switched CDU: prompt, type **set ldap binddn**, and press **Enter**. At the following prompt, type the FQDN and press **Enter**.

### **Example**

The following sets the FQDN for MSAD to 'cn=guest,cn=Users,dc=servertech,dc=com':

```
Switched CDU: set ldap binddn<Enter>
Enter Search Bind DN (Max characters 124):
cn=guest,cn=Users,dc=servertech,dc=com<Enter>
```

## Setting the search bind Distinguished Name (DN) password:

The Set LDAP BindPW command is used to set the password for the user account specified in the Search Bind DN. Maximum password size is 20 characters.

### *To set the Bind Password DN:*

At the Switched CDU: prompt, type **set ldap bindpw** and press **Enter**. At the following prompt, type the bind password and press **Enter**.

## Setting the group membership attribute:

The Set LDAP GroupAttr command is used to specify the name of user class attributes that lists distinguished names (DN), or names of groups that a user is a member of. Maximum string length is 30 characters.

### *To set Group Membership Attribute:*

At the Switched CDU: prompt, type **set ldap groupattr** and press **Enter**. At the following prompt, type the group membership attribute and press **Enter**.

### **Example**

The following sets the group membership attribute for MSAD to 'memberof':

```
Switched CDU: set ldap groupattr<Enter>
Enter Group Member Attr (Max character 30):
memberof<Enter>
```

### Setting the group membership value type:

The Set LDAP GroupType command is used to specify whether the values of Group Membership Attribute represent the Distinguished Name (DN) of a group or just the name of the group.

#### *To set group membership value type:*

At the Switched CDU: prompt, type **set ldap grouptype** followed by **DN** or **Name** and press **Enter**.

#### **Example**

The following sets group membership value to DN

```
Switched CDU: set ldap grouptype DN<Enter>
```

### Setting the user search base Distinguished Name (DN):

The Set LDAP UserBaseDN command is used to set the base (DN) for the login username search. This is where the search will start, and will include all sub-trees. Maximum size is 100 characters.

#### *To set the user search base DN:*

At the Switched CDU: prompt, type **set ldap userbasedn** and press **Enter**. At the following prompt, type the search base DN and press **Enter**.

#### **Example**

The following sets the DN user search base for MSAD to 'cn=Users,dc=servertech,dc=com':

```
Switched CDU: set ldap userbasedn<Enter>
Enter User Search Base DN (Max characters 100):
cn=Users,dc=servertech,dc=com<Enter>
```

### Setting the user search filter:

The Set LDAP UserFilter command is used to set the search filter for the username entered at the login prompt.

The search filter must be entered within parenthesis and adhere to the following format:

(searchfilter=%s)

where 'searchfilter' is the name of the attribute in the user class which has a value that represents the user's login name. In this string, the '%s' will be replaced by the entered username. Maximum string length is 100 characters.

#### *To set the user search filter:*

At the Switched CDU: prompt, type **set ldap userfilter** and press **Enter**. At the following prompt, type the User Search Filter and press **Enter**.

#### **Example**

The following sets the user search filter for MSAD to 'samaccountname':

```
Switched CDU: set ldap userfilter<Enter>
Enter User Search Filter (Max characters 100):
(samaccountname=%s)<Enter>
```

## Setting the authentication order:

The Set Authorder command sets the authentication order for remote authentication sessions. The PT45 supports two methods for authentication order - Remote -> Local and Remote Only.

The Remote -> Local method first attempts authentication with the Active Directory server and if unsuccessful with the local user database on the unit.

The Remote Only method attempts authentication only with the Active Directory server and if unsuccessful, access is denied.

---

**NOTE:** With the Remote Only method, if authentication fails due to a communication failure with the Active Directory server automatic authentication fallback will occur to authenticate with the local user data base on the PT45.

---

### *To set the authentication order:*

At the Switched CDU: prompt, type **set authorder**, followed by **remotelocal** or **remoteonly** and press **Enter**.

---

**NOTE:** Server Technology recommends not setting the authentication order to Remote Only until LDAP has been configured and tested.

---

## Displaying LDAP configuration information:

The Show LDAP command displays LDAP configuration information.

- Enabled-disabled status of LDAP support
- Directory Services server IP address and port
- Bind request password type and remote authentication order
- Search bind distinguished name and password
- User search base distinguished name and filter
- Group membership attribute and type

### *To display the LDAP configuration information:*

At the Switched CDU: prompt, type **show ldap** and press **Enter**.

### **Example**

The following command displays the LDAP configuration information:

```
Switched CDU: show ldap
LDAP Configuration
LDAP:          Enabled
Host 1:        98.76.54.32
Host 2:        ldap.servertech.com
Port:          8888
TLS/SSL:       Yes
Bind Type:     MD5
Auth Order:    Remote->Local
Search Bind
  DN: cd=guest,cn=Users,dc=servertech,dc=com
  Password: Test1
User Search
  Base DN: cn=Users,dc=servertech,dc=com
  Filter: (samaccountname=%s)
Group Membership
  Attribute: memberof
  Value Type: DN
```

## Setting the DNS IP address:

The Set DNS command sets the TCP/IP address of the Domain Name server (DNS).

---

**NOTE:** LDAP requires the definition of at least one Domain Name server.

---

To display the DNS configuration information, use the Show Network command.

### *To set the DNS IP address:*

At the Switched CDU: prompt, type **set**, followed by **dns1** or **dns2** and the Domain Name server's IP address. Press **Enter**.

### **Example**

The following command sets the primary Domain Name server IP address to 98.76.54.254:

```
Switched CDU: set dns1 98.76.54.254<Enter>
```

## Verifying the DNS configuration:

The Ping command can be used to verify the configuration of the DNS IP address.

### *To verify the DNS configuration:*

At the Switched CDU: prompt, type **ping**, followed by the domain component of the Directory Services server previously configured and press **Enter**.

### **Example**

The following command verifies the DNS configuration:

```
Switched CDU: ping servertech.com
Pinging servertech.com [98.76.54.32] with 64 bytes of data:
Reply from 98.76.54.32: bytes=64 pseq=0 triptime=0
Reply from 98.76.54.32: bytes=64 pseq=1 triptime=0
Reply from 98.76.54.32: bytes=64 pseq=2 triptime=0
Reply from 98.76.54.32: bytes=64 pseq=3 triptime=0
Reply from 98.76.54.32: bytes=64 pseq=4 triptime=0
```

## Configuring LDAP Groups

### **Creating an LDAP group:**

The Create LDAPGroup command creates an LDAP group.

### *To create an LDAP group:*

At the Switched CDU: prompt, type **create ldapgroup**, optionally followed by a 1-16 character group name (Spaces are not allowed, and LDAP group names are not case sensitive). Press **Enter**.

### **Example**

The following command creates the LDAP group PowerUser:

```
Switched CDU: create ldapgroup PowerUser<Enter>
```

### **Removing an LDAP group:**

The Remove LDAPGroup command removes an LDAP group.

### *To remove an LDAP group:*

At the Switched CDU: prompt, type **remove ldapgroup**, optionally followed by a group name. Press **Enter**.



## Setting LDAP group access level privileges:

The Set LDAPGroup Access command sets the access level privileges for an LDAP group. The PT45 has four defined access privilege levels; Admin, User, On-Only, and View-Only.

### *To set the access level privilege for an LDAP group :*

At the Switched CDU: prompt, type **set ldapgroup access**, followed by **admin**, **user**, **ononly** or **viewonly**, optionally followed by a LDAP group name and press **Enter**.

### **Examples**

The following command sets the LDAP group access level for LDAPAdmin to Admin:

```
Switched CDU: set ldapgroup access admin ldapadmin<Enter>
```

The following command sets the LDAP group access level for PowerUser to User:

```
Switched CDU: set ldapgroup access user poweruser<Enter>
```

## Granting and removing input status viewing privileges :

The Set LDAPGroup Envmon command grants or removes input status viewing privileges to/from an LDAP group.

### *To grant or remove input status viewing privileges for an LDAP group:*

At the Switched CDU: prompt, type **set ldapgroup envmon** followed by **on** or **off**, optionally followed by a group name and press **Enter**.

### **Example**

The following command grants input status viewing privileges to the LDAP group PowerUser:

```
Switched CDU: set ldapgroup envmon on poweruser<Enter>
```

## Displaying the LDAP access privilege levels:

The List LDAPGroups command displays all defined LDAP group with their access privilege level.

### *To display LDAP group access privilege levels:*

At the Switched CDU: prompt, type **list ldapgroups** and press **Enter**.

### **Example**

The following command displays all LDAP groups with their access privilege level:

```
Switched CDU: list ldapgroups<Enter>

LDAP          Access      Environmental
Group Name    Level       Monitoring
LDAPAdmin     Admin      Allowed
PowerUser     User       Allowed
User          On-Only    Not Allowed
Guest         View-Only  Not Allowed
```

## Adding outlet access to an LDAP group:

The Add OutletToLDAP command grants an LDAP group access to one or all outlets. To grant access for more than one outlet, but not all outlets, you must use multiple Add OutletToLDAP commands.

### *To grant outlet access to an LDAP group:*

At the Switched CDU: prompt, type **add outlettoldap**, optionally followed by an outlet name and a group name. Press **Enter**, or

Type **add outlettoldap all**, followed by a group name and press **Enter**.

### **Examples**

The following commands grant the LDAP group PowerUser access to outlets A1 and Webserver\_1:

```
Switched CDU:add outlettoldap .a1 poweruser<Enter>
Switched CDU:add outlettoldap WebServer_1 poweruser<Enter>
```

### Deleting outlet access for an LDAP group:

The Delete OutletFromLDAP command removes an LDAP group's access to one or all outlets. You cannot remove access to any outlet for an administrative level group.

#### *To delete outlet access for an LDAP group:*

At the Switched CDU: prompt, type **delete outletfromldap**, optionally followed by an outlet name and a group name. Press **Enter**, or

Type **delete outletfromldap all**, followed by a group name and press **Enter**.

### Adding outlet group access to an LDAP group:

The Add GroupToLDAP command grants an LDAP group access to a outlet group. To grant access for more than one outlet group, you must use multiple Add GroupToLDAP commands.

#### *To grant outlet group access to an LDAP Group:*

At the Switched CDU: prompt, type **add grouptoldap**, optionally followed by an outlet group name and an LDAP group name. Press **Enter**.

#### **Examples**

The following commands grants to LDAP group PowerUser access to the outlet groups ServerGroup\_1 and ServerGroup\_2:

```
Switched CDU:add grouptoldap servergroup_1 poweruser<Enter>
Switched CDU:add grouptoldap servergroup_2 poweruser<Enter>
```

### Deleting outlet group access for an LDAP group:

The Delete GroupFromLDAP command removes an LDAP group's access to a outlet group. You cannot remove access to any group for an administrative level group.

#### *To delete outlet group access for an LDAP group:*

At the Switched CDU: prompt, type **delete groupfromldap**, optionally followed by a outlet group name and an LDAP group name. Press **Enter**.

### Adding serial port access to an LDAP group:

The Add PortToLDAP command grants an LDAP group access to the serial port.

#### *To grant serial port access to an LDAP group:*

At the Switched CDU: prompt, type **add porttoldap console** and a group name. Press **Enter**.

### Deleting serial port access for an LDAP group:

The Delete PortFromLDAP command removes an LDAP group's access to the serial port. You cannot remove access to the serial port for an administrative level group.

#### *To delete serial port access for a user:*

At the Switched CDU: prompt, type **delete portfromldap console** and a group name. Press **Enter**.

## Displaying LDAP Group access:

The List LDAPGroup command displays all access rights for an LDAP group.

### *To display LDAP Group access:*

At the Switched CDU: prompt, type **list ldapgroup**, optionally followed by a group name. Press **Enter**.

### **Example**

The following command displays information about the LDAP group PowerUser:

```
Switched CDU: list ldapgroup poweruser<Enter>
Username: PowerUser
  Outlet  Outlet
  ID      Name
  .A1     DataServer_1
  .A2     WebServer_1
Groups:
  ServerGroup_1
  ServerGroup_2
More (Y/es N/o): Y
Ports:
  Port    Port
  ID      Name
  Console Console
```

Members of the PowerUser LDAP group can access the following outlets, outlet groups and serial ports: outlet A1 which has a descriptive name of DataServer\_1, outlet A2 which has a descriptive name of WebServer\_1, group ServerGroup\_1 group ServerGroup\_2 and Console serial port.

## **LDAPS (LDAP-over-TLS/SSL) Client Specifications**

Secure Sockets Layer (SSL) version 3

Transport Layer Security (TLS) version 1 (RFC 2246)

x.509 version 3 Server Certificates (RFC 2459) with RSA key sizes up to 4096 bits

Symmetric Cryptography Ciphers:

TLS\_RSA\_WITH\_3DES\_EDE\_CBC\_SHA (168-bit)

TLS\_RSA\_WITH\_DES\_CBC\_SHA (56-bit)

TLS\_RSA\_WITH\_AES\_128\_CBC\_SHA (128-bit)

TLS\_RSA\_WITH\_AES\_256\_CBC\_SHA (256-bit)

Server certificates are accepted and used on-the-fly.

A NULL client certificate is sent to the server if a client certificate is requested.

## LDAP Technical Specifications

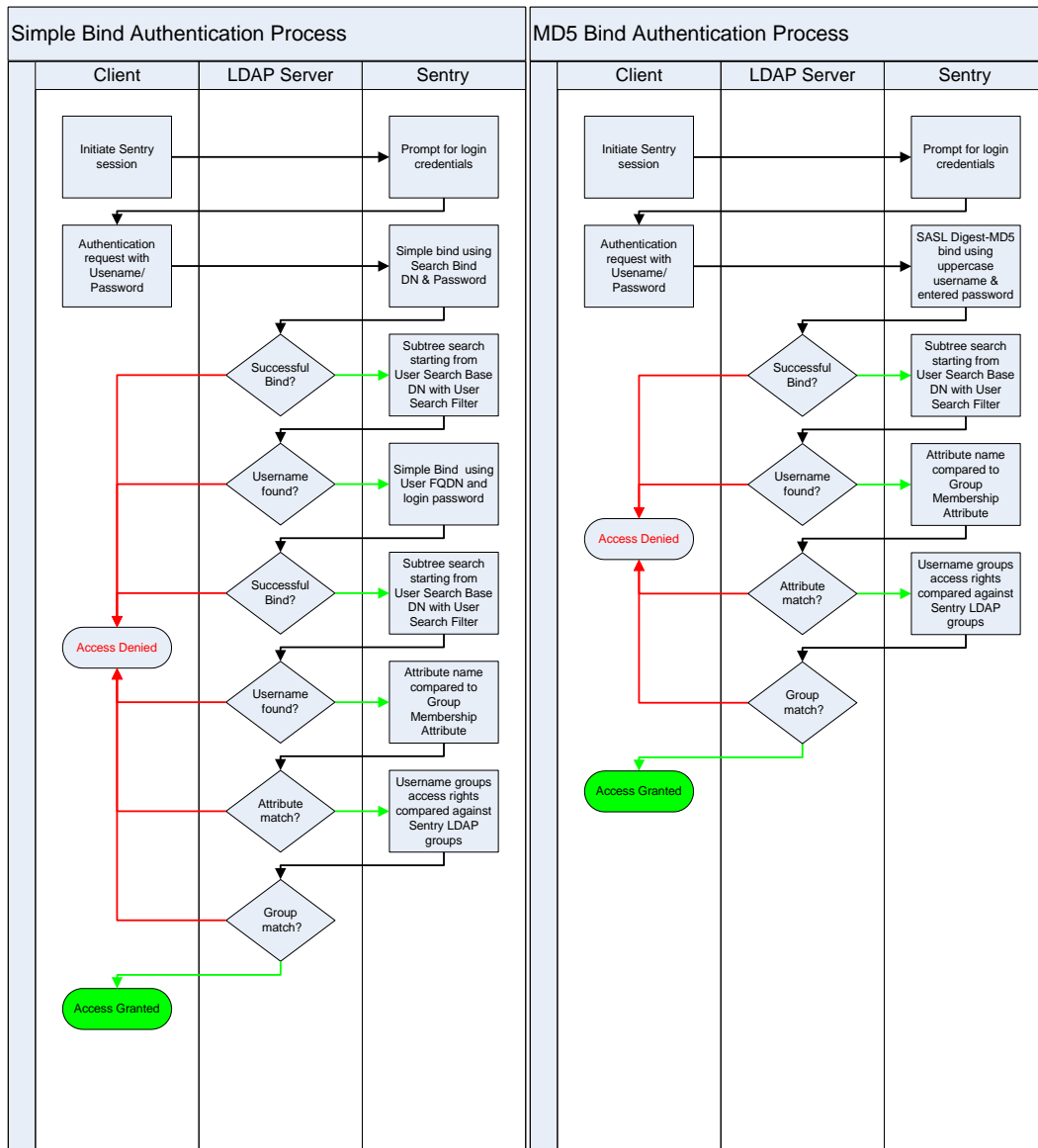

### LDAPS (LDAP-over-TLS/SSL) Client Specifications

Secure Sockets Layer (SSL)

Transport Layer Security (TLS) version 1 (RFC 2246)

x.509 version 3 Server Certificates (RFC 2459) with RSA key sizes up to 4096 bits

Symmetric Cryptography Ciphers:

TLS\_RSA\_WITH\_3DES\_EDE\_CBC\_SHA (168-bit)

TLS\_RSA\_WITH\_DES\_CBC\_SHA (56-bit)

TLS\_RSA\_WITH\_AES\_128\_CBC\_SHA (128-bit)

TLS\_RSA\_WITH\_AES\_256\_CBC\_SHA (256-bit)

Server certificates are accepted and used on `-the-fly`

A NULL client certificate is sent to the server if a client certificate is requested

## TACACS+

The PT45 supports the Terminal Access Controller Access Control System (TACACS+) protocol. This enables authentication and authorization with a central TACACS+ server; user accounts do not need to be individually created locally on each unit.

This allows administrators to pre-define and configure (in each unit, and in the TACACS+ server) a set of necessary TACACS+ privilege levels, and users access rights for each. User's access rights can then be assigned or revoked simply by making the user a member of one-or-more pre-defined PT45 TACACS+ privilege levels. User account rights can be added, deleted, or changed within TACACS+ without any changes needed on individual PT45 units.

The PT45 supports 16 different TACACS+ privilege levels; 15 are entirely configurable by the system administrator (1 is reserved for default Admin level access to all resources on the unit).

### TACACS+ Command Summary

Command	Description
Set Authorder	Specifies the authentication order for each new session attempt
Set TACACS	Enables/disables TACACS support
Set TACACS Host	Sets the IP address or hostname of the TACACS server
Set TACACS Key	Sets the TACACS encryption key
Set TACACS Port	Sets the TACACS server port number
Show TACACS	Displays TACACS configurations
Add GrouptoTACACS	Grants a TACACS account access to one or more groups
Add OutlettoTACACS	Grants a TACACS account access to one or more outlets
Add PorttoTACACS	Grants a TACACS account access to one or more serial ports
Delete GroupfromTACACS	Removes access to one or more groups for a TACACS account
Delete OutlettoTACACS	Removes access to one or more outlets for a TACACS account
Delete PortfromTACACS	Removes access to one or more serial ports for a TACACS account
Set TacPriv Access	Sets the access level for a TACACS account
Set TacPriv Envmon	Grants or removes privileges to view input and environmental monitoring status
List TacPrivs	Displays access levels for all TACACS accounts
List TacPriv	Displays all accessible outlet/groups/ports for a TACACS account

### Enabling and Setting up TACACS+ Support

There are a few configuration requirements for properly enabling and setting up TACACS+ support. Below is an overview of the minimum requirements:

1. Enable TACACS+ support.
2. Define the IP address and domain component of at least one TACACS+server.
3. Set the TACACS+ key configured on the supporting TACACS+server

#### **Enabling and disabling TACACS+ support:**

The Set TACACS command is used to enable or disable TACACS+ support.

#### ***To enable or disable TACACS+ support:***

At the Switched CDU: prompt, type **set tacacs**, followed by **enabled** or **disabled** and press **Enter**.

## Setting the TACACS+ server address:

The Set TACACS Host command sets the IP address or hostname of the TACACS+ server.

---

**NOTE:** Both IPv4 and IPv6 formats are accepted for IP address or hostname.

---

### *To set the TACACS+ server address:*

At the Switched CDU: prompt, type **set tacacs**, followed by **host1** or **host2** and the TACACS+ server's IP address or hostname. Press **Enter**.

### **Examples**

The following command sets the primary TACACS+ server address to 98.76.54.32:

```
Switched CDU: set tacacs host1 98.76.54.32<Enter>
```

The following command sets the secondary TACACS+ server address to tacacs.servertech.com:

```
Switched CDU: set tacacs host2 tacacs.servertech.com<Enter>
```

## Setting the TACACS+ encryption key:

The Set TACACS Key command sets the encryption key used to encrypt all data packets between the PT45 and the TACACS+ server. This key must match the key configured on the TACACS+ server.

### *To set the encryption key:*

At the Switched CDU: prompt, type **set tacacs key** and press **Enter**.

At the TACACS+ Key: prompt, type an encryption key of up to 60 alphanumeric and other typed characters - (ASCII 33 to 126 decimal) are allowed; encryption keys are case sensitive. Press **Enter**. To specify no password, press **Enter**.

At the Verify TACACS+ Key: prompt, retype the key. Press **Enter**. To verify no password, press **Enter** at the prompt.

### **Example**

```
Switched CDU: set tacacs key<Enter>
TACACS+ Key: <Enter>
Verify TACACS+ Key: <Enter>
```

For security, key characters are not displayed.

---

**NOTE:** A key size of zero results in no encryption being applied which can not be supported by the TACACS+ server and is not recommended for a production environment.

---

## Changing the TACACS port:

With TACACS support enabled, the PT45 sends TACACS requests to the default TACACS port number 49. This port number may be changed using the Set TACACS Port command.

### *To change the TACACS port:*

With TACACS support enabled, the PT45 sends TACACS requests to the default TACACS port number 49. This port number can be changed using the Set TACACS Port command.

### *To change the TACACS port:*

At the Switched CDU: prompt, type **set tacacs port**, followed by the port number and press **Enter**.

### **Example**

The following changes the TACACS port number to 50:

```
Switched CDU: set tacacs port 50<Enter>
```

## Setting the authentication order:

The Set Authorder command sets the authentication order for remote authentication sessions. The PT45 supports two methods for authentication order – Remote > Local and Remote Only.

The Remote > Local method first attempts authentication with the TACACS+ server and if unsuccessful with the local user database on the PT45 device.

The Remote Only method attempts authentication only with the TACACS+ server and if unsuccessful, access is denied.

---

**NOTE:** With the Remote Only method, if authentication fails due to a communication failure with the TACACS+ server automatic authentication fallback will occur to authenticate with the local user data base on the PT45 device.

---

### *To set the authentication order:*

At the Switched CDU: prompt, type **set authorder**, followed by **remotelocal** or **remoteonly** and press **Enter**.

---

**NOTE:** Server Technology recommends not setting the authentication order to Remote Only until the TACACS+ has been configured and tested.

---

## Displaying TACACS+ configuration information:

The Show TACACS command displays TACACS+ configuration information.

### *To display the TACACS configuration information:*

At the Switched CDU: prompt, type **show tacacs** and press **Enter**.

### **Example**

The following command displays the TACACS configuration information:

```
Switched CDU: show tacacs<Enter>
TACACS+ Configuration
  TACACS+:      Enabled
  Host 1:      98.76.54.32
  Host 2:      tacacs.servertech.com
  Port:        50
  TACACS+ Key: (Set)
  Auth Order:  Remote->Local
```

## Configuring TACACS+ Privilege Levels

### Setting TACACS+ account access level privileges:

The Set TacPriv Access command sets the access level privileges for a TACACS+ account. The PT45 has four defined access privilege levels; Admin, User, On-Only and View-Only.

### *To set the access level privilege for a TACACS+ account :*

At the Switched CDU: prompt, type **set tacpriv access**, followed by **admin**, **user**, **ononly** or **viewonly**, optionally followed by a TACACS+ account number and press **Enter**.

### **Examples**

The following command sets the TACACS+ account access level for account 14 to Admin:

```
Switched CDU: set tacpriv access admin 14<Enter>
```

The following command sets the TACACS+ account access level for account 5 to User:

```
Switched CDU: set tacpriv access user 5<Enter>
```

### Granting and removing input status viewing privileges:

The Set TacPriv Envmon command grants or removes input status viewing privileges to/from a TACACS+ account.

### *To grant or remove input status viewing privileges for a TACACS+ account:*

At the Switched CDU: prompt, type **set tacpriv envmon**, followed by **on** or **off**, optionally followed by a TACACS+ account number and press **Enter**.

### **Example**

The following command grants input status viewing privileges to the TACACS+ account 5:

```
Switched CDU: set tacpriv envmon on 5<Enter>
```

## Displaying the TACACS+ access privilege levels:

The List TacPrivs command displays all TACACS+ accounts with their access privilege levels.

### *To display TACACS+ account access privilege levels:*

At the Switched CDU: prompt, type **list tacprivs** and press **Enter**.

### **Example**

The following command displays all TACACS+ account with their access privilege level:

```
Switched CDU: list tacprivs<Enter>
TACACS      Access      Environmental
Account Name Level      Monitoring
TACAdmin    Admin      Allowed
PowerUser   User       Allowed
User        On-Only    Not Allowed
Guest       View-Only  Not Allowed
```

## Adding outlet access to a TACACS+ account:

The Add OutletToTACACS command grants a TACACS+ account access to one or all outlets. To grant access for more than one outlet, but not all outlets, you must use multiple Add OutletToTACACS commands.

### *To grant outlet access to a TACACS+ account:*

At the Switched CDU: prompt, type **add outlettotacacs**, optionally followed by an outlet name and a TACACS+ account number. Press **Enter**, or

Type **add outlettotacacs all**, followed by a TACACS+ account number and press **Enter**.

### **Examples**

The following commands grant the a TACACS+ account 5 access to outlets A1 and Webserver\_1:

```
Switched CDU:add outlettotacacs .a1 5<Enter>
Switched CDU:add outlettotacacs WebServer_1 5<Enter>
```

## Deleting outlet access for a TACACS+ account:

The Delete OutletFromTACACS command removes a TACACS+ account's access to one or all outlets. You cannot remove access to any outlet for an administrative level account.

### *To delete outlet access for a TACACS+ account:*

At the Switched CDU: prompt, type **delete outletfromtacacs**, optionally followed by an outlet name and a TACACS+ account number. Press **Enter**, or

Type **delete outletfromtacacs all**, followed by a TACACS+ account number and press **Enter**.

## Adding outlet group access to a TACACS+ account:

The Add GroupToTACACS command grants a TACACS+ account access to an outlet group. To grant access for more than one outlet group, you must use multiple Add GroupToTACACS commands.

### *To grant outlet group access to a TACACS+ account:*

At the Switched CDU: prompt, type **add grouptotacacs**, optionally followed by an outlet group name and a TACACS+ account number. Press **Enter**.

### **Examples**

The following commands grants to a TACACS+ account number 5 access to the outlet groups ServerGroup\_1 and ServerGroup\_2:

```
Switched CDU:add grouptotacacs servergroup_1 5<Enter>
Switched CDU:add grouptotacacs servergroup_2 5<Enter>
```



### Deleting outlet group access for a TACACS+ account:

The Delete GroupFromTACACS command removes a TACACS+ account's access to an outlet group. You cannot remove access to any group for an administrative level account.

#### *To delete outlet group access for a TACACS+ account:*

At the Switched CDU: prompt, type **delete groupfromtacacs**, optionally followed by a outlet group name and a TACACS+ account number. Press **Enter**.

### Adding serial port access to a TACACS+ account:

The Add PortToTACACS command grants a TACACS+ account access to the serial port.

#### *To grant serial port access to a TACACS+ account:*

At the Switched CDU: prompt, type **add porttotacacs console** and a TACACS+ account number. Press **Enter**.

### Deleting serial port access for a TACACS+ account:

The Delete PortFromTACACS command removes a TACACS+ account's access to the serial port. You cannot remove access to the serial port for an administrative level account.

#### *To delete serial port access for a TACACS+ account:*

At the Switched CDU: prompt, type **delete portfromtacacs console** and a TACACS+ account number. Press **Enter**.

### Displaying TACACS account access:

The List TacPriv command displays all access rights for a TACACS+ account.

#### *To display TACACS account access:*

At the Switched CDU: prompt, type **list tacpriv**, optionally followed by a TACACS+ account. Press **Enter**.

### **Example**

The following command displays information about the TACACS+ account 1:

```
Switched CDU: list tacpriv 1<Enter>
TACACS+ Privilege Level: 1
  Outlet  Outlet
  ID      Name
  .A1     DataServer_1
  .A2     WebServer_1
Groups:
  ServerGroup_1
  ServerGroup_2
More (Y/es N/o): Y
Ports:
  Port ID  Port Name
  Console  Console
```

Members of the TACACS privilege level 1 account can access the following outlets, outlet groups and serial ports: outlet A1 which has a descriptive name of DataServer\_1, outlet A2 which has a descriptive name of WebServer\_1, group ServerGroup\_1 group ServerGroup\_2 and Console serial port.

## **TACACS+ Technical Specifications**

Authentication START Packet includes:

```
action = 1 (TAC_PLUS_AUTHEN_LOGIN)
priv_lvl = 0 (TAC_PLUS_PRIV_LVL_MIN)
authen_type = 1 (TAC_PLUS_AUTHEN_TYPE_ASCII)
service = 1 (TAC_PLUS_AUTHEN_SVC_LOGIN)
user = (entered username)
port = (access path into the PT45)
rem_addr = 'Sentry3_XXXXXX' (XXXXXX is last six digits of MAC address)
data = "" (null)
```

---

**NOTE:** The password is sent in a CONTINUE packet.

---

Authorization REQUEST Packet includes:

```
authen_method = 6 (TAC_PLUS_AUTHEN_METH_TACACSPLUS)
priv_lvl = 0 (TAC_PLUS_PRIV_LVL_MIN)
authen_type = 1 (TAC_PLUS_AUTHEN_TYPE_ASCII)
authen_service = 1 (TAC_PLUS_AUTHEN_SVC_LOGIN)
user = (entered username)
port = (access path into the PT45)
rem_addr = 'Sentry3_XXXXXX' (XXXXXX is last six digits of Ethernet MAC address)
service = 'shell' (for exec)
cmd = "" (null)
```

---

**NOTE:** The access paths into the PT45 which support TACACS+ are 'Console', 'Telnet', 'SSH', 'HTTP' and 'HTTPS'. In the case of 'Console' and 'Modem', an administrator is allowed to rename these ports in which case the assigned name is used.

---

## RADIUS

The PT45 supports the Remote Authentication Dial-in User Service (RADIUS) protocol. RADIUS provides a centralized network protocol to enable remote authentication and authorization, such as user names and passwords. With a central RADIUS server, user accounts do not need to be individually created locally on each unit. This allows administrators to pre-define and configure (in each PT45 and in the RADIUS server), a set of necessary RADIUS privilege levels and user access rights for each level.

RADIUS is also used in enterprise-wide networks because it provides the administrator with high performance, less memory usage, less CPU cycles on routers and switches, and an open standard that is easily interoperable within the network.

In addition to the protocol-required attributes, the RADIUS authentication process can be extended by using private vendor-specific attributes (VSA). This extension allows Server Technology to create its own proprietary attributes to support features and services using the PT45 in the RADIUS authentication process.

### RADIUS Command Summary

Command	Description
Set Authorder	Specifies the authentication order for each new session attempt
Set RADIUS	Enables or disables RADIUS support
Set RADIUS...Server	Configures the address of the RADIUS server
Set RADIUS...Secret	Sets the shared secret for the RADIUS server
Set RADIUS...Port	Sets the port number of the RADIUS server
Set RADIUS...Timeout	Configures the timeout interval for the RADIUS server
Set RADIUS...Retries	Sets the number of retries for the RADIUS server
Show RADIUS	Displays RADIUS configuration settings

### Enabling and Setting Up RADIUS Support

The following configuration tasks are required to properly enable and set up RADIUS support on the primary and secondary RADIUS servers.

#### Enabling and disabling RADIUS support:

The Set RADIUS command enables or disables RADIUS support.

#### *To enable or disable RADIUS support:*

At the Switched CDU: prompt, type **set radius**, followed by **enabled** or **disabled**, and press **Enter**.

#### Setting the authentication order:

The Set Authorder command sets the authentication order for remote authentication sessions. The PT45 supports two methods for authentication order: Remote -> Local and Remote Only.

The Remote -> Local method first attempts authentication with the RADIUS server, and, if unsuccessful, then attempts authentication with the local user database on the PT45 device.

The Remote Only method attempts authentication only with the RADIUS server, and, if unsuccessful, access is denied.

---

**NOTE:** With the Remote Only method, if authentication fails due to a communication failure with the RADIUS server automatic authentication fallback will occur to authenticate with the local user data base on the PT45 device.

---

#### *To set the authentication order:*

At the Switched CDU: prompt, type **set authorder**, followed by **remotelocal** or **remoteonly** and press **Enter**.

---

**NOTE:** Server Technology recommends not setting the authentication order to Remote Only until RADIUS has been configured and tested.

---

## Setting the RADIUS server address:

The Set RADIUS Server command sets the IP address or hostname of the primary or secondary server used for RADIUS authentication requests.

---

**NOTE:** Both IPv4 and IPv6 formats are accepted for primary/secondary IP address or hostname.

---

### *To set the RADIUS server address:*

At the Switched CDU: prompt, type **set radius**, followed by **primary** or **secondary**, followed by **server**, and the RADIUS server's IP address or hostname (maximum 63 characters). Press **Enter**.

### **Examples**

The following command sets the primary RADIUS server address to 98.76.54.32:

```
Switched CDU: set radius primary server 98.76.54.32<Enter>
```

The following command sets the secondary RADIUS server address to radius.servertech.com:

```
Switched CDU: set radius secondary server radius.servertech.com<Enter>
```

## Setting the RADIUS secret:

The Set RADIUS Secret command sets the shared secret for the server used for RADIUS authentication requests.

### *To set the shared secret:*

At the Switched CDU: prompt, type **set radius**, followed by **primary** or **secondary**, and followed by **secret**. Press **Enter**.

Enter the shared secret and press **Enter**. For security, shared secret characters are not displayed.

The secret that was set for the primary server will not be cleared when setting the secret for the secondary server, and vice versa.

## Changing the RADIUS port number:

The Set RADIUS Port command sets the server port number for RADIUS authentication requests.

### *To change the port number:*

At the Switched CDU: prompt, type **set radius**, followed by **primary** or **secondary**, followed by **port**, and the port number (1-65535). Press **Enter**.

The default is 1812.

### **Example**

The following command sets the secondary RADIUS server port number to 1855:

```
Switched CDU: set radius secondary port 1855<Enter>
```

## Setting the RADIUS timeout value:

The Set RADIUS Timeout command sets the time interval to wait for a reply from the RADIUS server before resending the authentication request.

### *To set the timeout value:*

At the Switched CDU: prompt, type **set radius**, followed by **primary** or **secondary**, followed by **timeout**, and the time interval in seconds (1-30). Press **Enter**.

### **Examples**

The following command sets the primary RADIUS server timeout value to 15 seconds:

```
Switched CDU: set radius primary timeout 15<Enter>
```

The following command sets the secondary RADIUS server timeout value to 5 seconds:

```
Switched CDU: set radius secondary timeout 5<Enter>
```

## Setting the number of RADIUS server retries:

The Set RADIUS Retries command specifies the number of times an authentication request is sent to the RADIUS server. The PT45 will attempt authentication with the primary server until the number of retries is reached, then will attempt authentication with the secondary server. If the PT45 does not receive a response from these attempts, the authentication request will be rejected.

Enter the number of retries in the Primary and/or Secondary Retries field and press **Apply**.

The valid retries range is 0-10; default is 2.

### *To set the number of retries:*

At the Switched CDU: prompt, type **set radius**, followed by **primary** or **secondary**, followed by **retries**, and followed by the number of retries (0-10). Press **Enter**.

### **Examples**

The following command sets the retries for the primary RADIUS server to 5:

```
Switched CDU: set radius primary retries 5<Enter>
```

The following command sets the retries for the secondary RADIUS server to 2:

```
Switched CDU: set radius secondary retries 2<Enter>
```

## Displaying RADIUS configuration information:

The Show RADIUS command displays RADIUS configuration information.

### *To display the RADIUS configuration information:*

At the Switched CDU: prompt, type **show radius** and press **Enter**.

### **Example**

The following command displays the RADIUS configuration information:

```
Switched CDU: show radius<Enter>
RADIUS Configuration

RADIUS:           Enabled
Auth Order:       Remote->Local
Primary Server:
  Shared Secret:  ****
  Port:           1812
  Timeout:        15 seconds
  Retries:        5
Secondary Server:
  Shared Secret:
  Port:           1855
  Timeout:        5 seconds
  Retries:        2
```

## Vendor-Specific Attributes (VSA):

Server Technology has defined and formatted RADIUS vendor-specific attributes (VSA) in the **dictionary.sti** file, which is available from Server Technology. The PT45 unit is configured to recognize and use the configuration values in the file as specified by the network administrator, indicating to the RADIUS server that the defined attributes are based on Server Technology's unique enterprise vendor code.

Using the format of the **dictionary.sti** file (located on the Server Technology FTP site at <ftp.servertech.com>), the PT45 RADIUS implementation supports the following vendor-specific attributes:

### Vendor-Specific Attribute (VSA) Descriptions

Attribute	Description
STI-Access-Level	Indicates user access level for the PT45; values are 1-6 as follows; a valid access level is required or access to the unit is denied.  Valid Access Levels: 1 = Admin 2 = Power User 3 = User 4 = Reboot Only 5 = On Only 6 = View Only
STI-Env-Mon	Determines user access rights to environmental monitoring; values are Yes or No. For the STI-Access-Level value other than 1 (Admn), if STI-Env-Mon is not included for a user, default is no.
STI-Outlets	Specifies user access rights to outlets; values are space-delimited strings of absolute IDs, names, or the special keyword "ALL". String values are case-sensitive and limited to 253 characters. This attribute can be repeated to append strings that declare additional access rights. For STI-Access Level values other than 1 (Admn) and 2 (Power User), if STI-Outlets is not included for a user, the default is no outlet.
STI-Groups	Specifies user access rights to groups of outlets; values are space-delimited strings of absolute IDs, names, or the special keyword "ALL". String values are case-sensitive and limited to 253 characters. This attribute can be repeated to append strings that declare additional access rights. For STI-Access Level values other than 1 (Admn) and 2 (Power User), if STI-Groups is not included for a user, the default is no group.
STI-Ports	Specifies user access rights to ports; values are space-delimited strings of absolute IDs, names, or the special keyword "ALL". String values are case-sensitive and limited to 253 characters. This attribute can be repeated to append strings that declare additional access rights. For STI-Access Level values other than 1 (Admn) and 2 (Power User), if STI-Ports is not included for a user, the default is no ports.

**NOTE:** User access levels must be configured using the **dictionary.sti** file. If the administrator does not use the **dictionary.sti** file to configure a user, the user will not have access rights to the PT45.

### Examples:

Administrator with full access and configuration rights:

```
sti-admin Auth-Type := Local, User-Password == "admin"  
STI-Access-Level = Admin
```

Power user with environmental monitoring allowed and full outlet/group/port access rights:

```
sti-power Auth-Type := Local, User-Password == "power"  
STI-Access-Level = Power-User,  
STI-Env-Mon = Yes
```

User with environmental monitoring not allowed and specific outlet/group/port access rights:

```
sti-user Auth-Type := Local, User-Password == "user"  
STI-Access-Level = User,  
STI-Env-Mon = No,  
STI-Outlets = ".A1 .A2 Rtr1 Rtr2 Srvr1 Srvr2",  
STI-Outlets += ".A3 .A4 Rtr3 Rtr4 Srvr3 Srvr4",  
STI-Groups = "Routers Servers",  
STI-Ports = "Console"
```

View-only user with environmental monitoring allowed and all outlet and group access rights:

```
sti-view Auth-Type := Local, User-Password == "view"  
STI-Access-Level = View-Only,  
STI-Env-Mon = Yes,  
STI-Outlets = "ALL",  
STI-Outlets = "ALL"
```

## Logging

The PT45 supports logging of system events both internally and externally. An internal log of more than 4000 events is automatically maintained and is reviewable by administrative users. For permanent/long-term log storage, the unit supports the Syslog protocol. And for immediate notification, the unit supports Email notifications.

Log entries include a sequential entry number, a date/time stamp and an event message. The event message is preceded with a message 'type' heading and if the event is tied to a user, the username will be included.

**NOTE:** For date/time stamp support, the SNTP server support must be configured. For information about configuration, see the "SNTP" section.

The PT45 supports the following event message headers:

- AUTH: All authentication attempts.
- POWER: All power state change requests.
- CONFIG: All system configuration changes.
- EVENT: All general system events. Example: over/under threshold event.

### Internal System Log

The internal system log is stored in the local memory and has support for up to 4097 continuously aging entries. The internal system log is only available to administrative users.

### Syslog

The PT45 Syslog support is RFC3164-compliant and enables off-unit viewing and storage of log messages. The unit supports external logging to up to two Syslog servers.

#### Syslog Command Summary

Command	Description
Set Syslog HostIP	Sets the IP address of the Syslog server
Set Syslog Port	Sets the Syslog server port number
Show Syslog	Displays all Syslog configuration information

#### Setting the Syslog server IP address:

The Set Syslog HostIP command sets the TCP/IP address of the Syslog server.

##### *To set the Syslog server IP address:*

At the Switched CDU: prompt, type **set syslog**, followed by **hostip1** or **hostip2** and the Syslog server's IP address. Press **Enter**.

##### **Example**

The following command sets the primary Syslog server IP address to 56.47.38.29:

```
Switched CDU: set syslog hostip1 56.47.38.29<Enter>
```

#### Changing the Syslog server port:

With Syslog support enabled, the Syslog server watches and responds to requests on the default Syslog port number 514. This port number can be changed using the Set Syslog Port command.

##### *To change the Syslog port:*

At the Switched CDU: prompt, type **set syslog port**, followed by the port number and press **Enter**.

##### **Example**

The following changes the Syslog port number to 411:

```
Switched CDU: set syslog port 411<Enter>
```

## Displaying Syslog configuration information:

The Show Syslog command displays Syslog configuration information.

### *To display the Syslog configuration information:*

At the Switched CDU: prompt, type **show syslog** and press **Enter**.

### **Example**

The following command displays the Syslog configuration information:

```
Switched CDU: show syslog<Enter>
SYSLOG Configuration
  Primary Syslog Server IP Address:    56.47.38.29
  Secondary Syslog Server IP Address:  0.0.0.0
  Syslog Server Port:                 411
```

## Email

### **Email Command Summary**

<b>Command</b>	<b>Description</b>
Set Email	Enables or disables Email notification support
Set Email SMTP Host	Sets the SMTP Host IP address or hostname
Set Email SMTP Port	Sets the SMTP server port number
Set Email From	Sets the email 'From' address
Set Email PrimaryTo	Sets the primary recipient email address
Set Email SecondaryTo	Sets the secondary recipient email address
Set Email Event	Enables or disables notification of general system events
Set Email Auth	Enables or disables notification of all authentication attempts
Set Email Power	Enables or disables notification of power state change requests
Set Email Config	Enables or disables notification of configuration changes
Show Email	Displays all Email configuration information

### **Enabling or disabling Email notification Support:**

The Set Email command enables or disables Email notification support.

### *To enable or disable Email notification support:*

At the Switched CDU: prompt, type **set email**, followed by **enabled** or **disabled** and press **Enter**.

### **Setting the SMTP server address:**

The Set Email Host command sets the IP address or hostname of the SMTP server.

### *To set the SMTP server address:*

At the Switched CDU: prompt, type **set email smtp host**, followed by the SMTP server's IP address or hostname and press **Enter**.

### **Examples**

The following command sets the SMTP server address to 55.55.55.55:

```
Switched CDU: set email smtp 55.55.55.55<Enter>
```

The following command sets the SMTP server address to email.servertech.com:

```
Switched CDU: set email smtp email.servertech.com<Enter>
```



### Changing the SMTP server port:

With SMTP support enabled, the PT45 sends SMTP requests to the default SMTP port number 25. This port number can be changed using the Set Email SMTP Port command.

#### *To change the TACACS port:*

At the Switched CDU: prompt, type **set email smtp port**, followed by the port number and press **Enter**.

#### **Example**

The following changes the SMTP port number to 5555:

```
Switched CDU: set email smtp port 5555<Enter>
```

### Setting the 'From' email address:

The Set Email From command sets the 'from' email address. By default, this is set to 'Sentry3\_' plus the last three octets of the unit's MAC address. Example: 'Sentry3\_510c90@'

#### *To set the 'From' email address:*

At the Switched CDU: prompt, type **set email from**, followed by the originating email address and press **Enter**.

#### **Example**

The following command sets the 'from' email address to Rack14UNIT1@servertech.com:

```
Switched CDU: set email from Rack14UNIT1@servertech.com<Enter>
```

### Setting the 'To' email address:

The Set Email PrimaryTo and Set Email SecondaryTo commands set the recipient email addresses.

#### *To set the 'To' email address:*

At the Switched CDU: prompt, type **set email**, followed by **primaryto** or **secondaryto** and the destination email address. Press **Enter**.

#### **Examples**

The following command sets the primary 'to' email address to DayAdmin@servertech.com:

```
Switched CDU: set email primaryto DayAdmin@servertech.com<Enter>
```

The following command sets the secondary 'to' email address to NiteAdmin@servertech.com:

```
Switched CDU: set email secondaryto NiteAdmin@servertech.com<Enter>
```

### Enabling or disabling event notification types:

The Set Email Event, Set Email Auth, Set Email Power and Set Email Config commands enable or disable email notification of the event types.

#### *To enable or disable event notification types:*

At the Switched CDU: prompt, type **set email**, followed by **event**, **auth**, **power** or **config** and **enabled** or **disabled**. Press **Enter**.

#### **Examples**

The following command sets the enables email notification general system events:

```
Switched CDU: set email event enabled<Enter>
```

The following command sets the disables email notification authentications attempts:

```
Switched CDU: set email auth disable<Enter>
```

## Displaying Email configuration information:

The Show Email command displays Email configuration information.

### *To display the Email configuration information:*

At the Switched CDU: prompt, type **show email** and press **Enter**.

### **Example**

The following command displays the Email configuration information:

```
Switched CDU: show email
Email/SMTP Configuration
  Email Notifications:      Enabled
  SMTP
    Host:                   email.servertech.com
    Port:                   25
    Authentication Type:    Any
    Authenticate With:      'From' Address
    Username:               djones
    Password:               *****
    'From' Address:         Sentry3_50e021@
    Primary 'Send To' Addr: techsupport@servertech.com
    Secondary 'Send To' Addr:
    Subject ID:              [Sentry3_5246401]
  EVENT Messages:         Enabled
  AUTH Messages:          Disabled
  POWER Messages:         Disabled
  CONFIG Messages:        Disabled
```

## Upload/Download

The unit supports the ability to upload and download system configurations using a standard FTP client. This feature enables for backup and restoration of system configuration as well as upload of 'template' configurations to ease large initial equipment deployments.

### Upload/Download Command Summary

Command	Description
Set FTP Server	Enables or disables the FTP server
Show FTP	Displays FTP configuration information

### Integrated FTP Server

The PT45 supports an integrated FTP Server which must be enabled for Upload/Download support. The FTP Server supports a single user at a time. Once an administrative user has authenticated with the PT45 FTP Server, standard FTP client commands can be used to upload or download configurations for the unit.

**NOTE:** The integrated FTP Server does not support web browser FTP file transfers. A non-web-browser is required for all Upload/Download requests.

### Enabling and disabling the FTP server:

The Set FTP Server command is used to enable or disable the integrated FTP server.

#### *To enable or disable the FTP server:*

At the Switched CDU: prompt, type **set ftp server**, followed by **enabled** or **disabled** and press **Enter**.

### FTP Configuration Files

The FTP server supports upload/download of two configuration files: CONFIG.BIN and NETWORK.INI. These files can be uploaded or downloaded using FTP PUT and GET operations.

- CONFIG.BIN This file contains the entire configuration of the PT45 excluding TCP/IP settings, serial/factory-only configurations, the x.509 certificate (SSL) and SSH keys. This file is encoded to keep all data (including usernames, passwords etc.) out of plain view. **This file is NOT editable.**
- FTP.INI This file contains only the FTP settings (FTP Host, username, password, filepath, filename and automatic updates support). This file is user readable and editable 'plain text' file.
- NETWORK.INI This file contains only the TCP/IP settings (IP address, subnet mask, gateway, DNS1 and DNS2). This file is user readable and editable 'plain text' file.
- SNTP.INI This file contains only the SNTP settings (SNTP Hosts and GMT offset). This file is user readable and editable 'plain text' file.

**NOTE:** The CONFIG.BIN file while encoded is not encrypted and susceptible to decoding using simple tools. Server Technology recommends the secure storage of CONFIG.BIN backup images.

## Upload/Download Process

### **GETting a configuration file (Download):**

1. Open the FTP client.  
*In a Windows environment, in the Run window type **ftp** and press **Enter**.*
2. At the prompt, type **open**, followed by the IP address of the PT45 and press **Enter**.  
FTP> open 12.34.56.78<Enter>
3. Authenticate with the appropriate administrative username and password.
4. At the prompt, type **get**, followed by the filename and press **Enter**.  
FTP> get config.bin<Enter>
5. At the prompt, type **close** to close the connection to the PT45.  
FTP> close

### **PUTting a configuration file (Upload):**

---

**NOTE:** Uploading the CONFIG.BIN file takes considerably longer than the NETWORK.INI file. When uploading both, Server Technology recommends uploading the NETWORK.INI file first.

---

1. Open the FTP client.  
*In a Windows environment, in the Run window type **ftp** and press **Enter**.*
2. At the prompt, type **open**, followed by the IP address of the PT45 and press **Enter**.  
FTP> open 12.34.56.78<Enter>
3. Authenticate with the appropriate administrative username and password.
4. At the prompt, type **put**, followed by the filename and press **Enter**.  
FTP> put network.ini<Enter>
5. At the prompt, type **close** to close the connection to the PT45 and force a restart of the device.  
FTP> close

## Remote Shutdown

The PT45 supports the ability to initiate an orderly shutdown of remote servers, protecting open application files prior to the server being powered down. Shutdown signaling is initiated over the existing TCP/IP network and requires the use of a Remote Shutdown Agent.

With the Remote Shutdown Agent installed on the server and Shutdown configured on the PT45, the unit will initiate an orderly shutdown of the server for all actions that would remove power from the outlet such as Off and Reboot commands.

1. Off or Reboot command is received by the PT45.
2. Shutdown signal is sent to the Remote Shutdown Agent on the target server.
3. Remote Shutdown Agent initiates a graceful shutdown of the target server and includes the ability to execute user-defined scripts to perform custom activities, such as safely shutting down open databases.
4. PT45 removes power from the outlet.

**NOTE:** Remote Shutdown is also supported by the extended feature set of Smart Load-Shedding. Graceful shutdown is initiated by Smart Load-Shedding events such as high temperature, high infeed load and UPS 'On Battery' conditions. For additional information on Smart Load-Shedding, please contact your Server Technology sales representative.

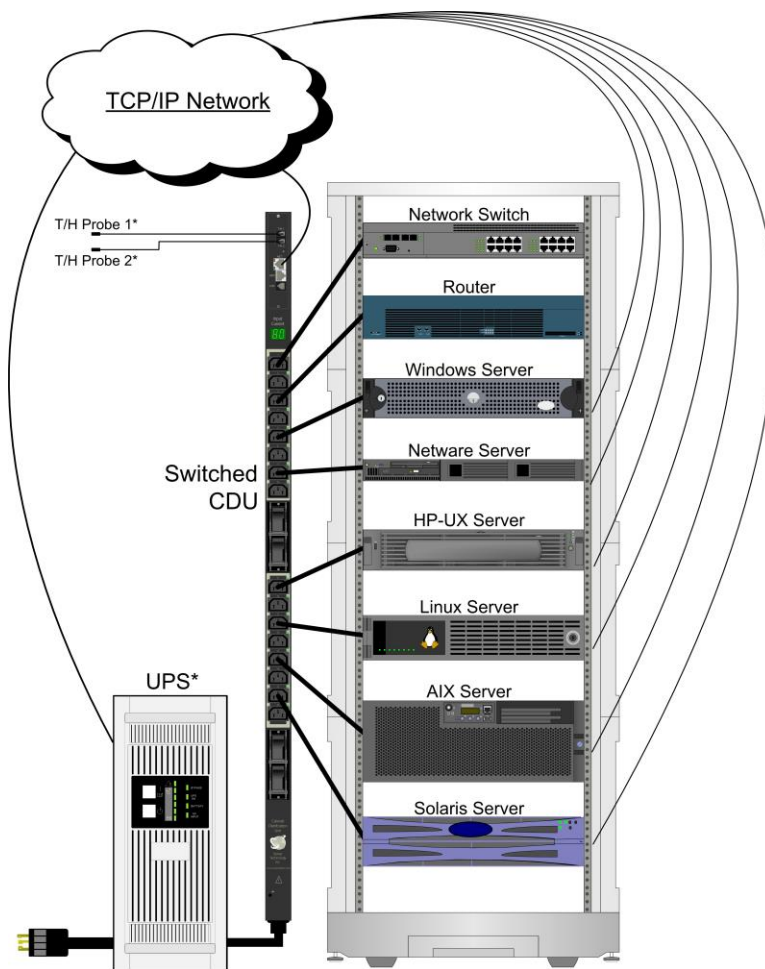

**Remote Shutdown Diagram**

## **Supported Operating Systems**

Remote Shutdown Agents are available for the following operating systems:

- Windows 2000, 2003, XP
- Linux Red Hat 7.3, 8.0  
Red Hat Enterprise 2.1 ES (update 5), 3.0 ES (update 4)  
Novell SUSE Linux Enterprise Server
- Unix HP-UX 11.0, 11i v1, 11i v2  
IBM AIX 4.3, 5.3  
Sun Solaris 8, 9, 10
- Novell Netware 6

The Remote Shutdown Agents are available for download from the [Server Technology website](#).

## **Shutdown Agent Installation**

### **Windows**

1. Browse to the location of the Remote Shutdown Agent install files.
2. Run **Setup.exe** by double-clicking on the icon.
3. Reply to the standard installation prompts.
4. For additional security, when prompted enter the IP address of the PT45 unit that will be sending the shutdown signal.

---

**NOTE:** If left blank, any PT45 unit can send a shutdown signal to the server.

---

### **Linux**

5. Browse to the location of the Remote Shutdown Agent install files.
6. Run **SetupRA**.
7. For additional security, when prompted enter the IP address of the PT45 unit that will be sending the shutdown signal.

---

**NOTE:** If left blank, any PT45 unit can send a shutdown signal to the server.

---

### **Unix**

8. Browse to the location of the Remote Shutdown Agent install files.
9. Run **Install**.
10. For additional security, when prompted enter the IP address of the PT45 unit that will be sending the shutdown signal.

---

**NOTE:** If left blank, any PT45 unit can send a shutdown signal to the server.

---

### **Netware**

11. Browse to the location of the Remote Shutdown Agent install files.
12. From the NetWare system console, load the configuration module (**pmconfig.nlm**) using the default path.
13. For additional security, when prompted enter the IP address of the PT45 unit that will be sending the shutdown signal.

---

**NOTE:** If left blank, any PT45 unit can send a shutdown signal to the server.

---

## **Enabling and Setting up Remote Shutdown Support**

### **Remote Shutdown Command Summary**

<b>Command</b>	<b>Description</b>
Set Outlet Host	Sets the target server Host IP address or hostname
Set Outlet Shutdown	Enables or Disables Remote Shutdown
Set Outlet Shutdown Delay	Sets the outlet Remote Shutdown delay
Set Outlet Script	Enables or disables shutdown script delays
Set Outlet Script Delay	Sets the outlet shutdown script delay
Show Shutdown	Displays Remote Shutdown configuration information

### **Enabling or disabling Remote Shutdown support:**

The Set Outlet Shutdown command enables or disables Remote Shutdown support for an outlet.

#### ***To enable or disable Remote Shutdown support:***

At the Switched CDU: prompt, type **set outlet shutdown**, followed by **yes** or **no**, and the outlet ID. Press **Enter**.

#### ***Example***

The following command enables Remote Shutdown from outlet .a1:

```
Switched CDU: set outlet shutdown yes .a1<Enter>
```

### **Setting the Remote Shutdown delay:**

The Set Outlet Shutdown Delay command sets the Remote Shutdown delay for an outlet.

#### ***To set the Remote Shutdown delay:***

At the Switched CDU: prompt, type **set outlet shutdown delay**, followed by the outlet ID, and a value from 1-900 (in seconds). Press **Enter**.

#### ***Example***

The following command sets the Remote Shutdown delay for outlet .a2 to 120 seconds:

```
Switched CDU: set outlet shutdown delay .a2 120<Enter>
```

### **Setting the outlet host address:**

The Set Outlet Host command set the IP address or hostname for an outlet. Hostnames can be up to 60 characters long.

#### ***To set the outlet host address:***

At the Switched CDU: prompt, type **set outlet host**, followed by the outlet ID, and the IP address or hostname. Press **Enter**.

#### ***Example***

The following command set the hostname for outlet .a1 to 'Windows2003':

```
Switched CDU: set outlet host .a1 Windows2003<Enter>
```

### **Enabling or disabling shutdown script support:**

The Set Outlet Script command enables or disables shutdown script support for an outlet.

#### ***To enable or disable shutdown script support:***

At the Switched CDU: prompt, type **set outlet script**, followed by **yes** or **no**, and the outlet ID. Press **Enter**.

#### ***Example***

The following command enables Remote Shutdown from outlet .a1:

```
Switched CDU: set outlet script yes .a1<Enter>
```

### **Setting the shutdown script delay:**

The Set Outlet Script Delay command sets the shutdown script delay for an outlet.

#### ***To set the shutdown script delay:***

At the Switched CDU: prompt, type **set outlet script delay**, followed by the outlet ID, and a value from 1 to 15 (in minutes). Press **Enter**.

#### ***Example***

The following command sets the shutdown script delay for outlet .a1 to 10 minutes:

```
Switched CDU: set outlet shutdown delay .a1 10<Enter>
```

### **Displaying Remote Shutdown information:**

The Show Shutdown command displays all shutdown configuration information.

- Outlet ID and descriptive name
- Remote Shutdown settings
- Shutdown script setting

#### ***To display shutdown information:***

At the Switched CDU: prompt, type **show shutdown** and press **Enter**.

#### ***Example***

The following command displays all shutdown information:

```
Switched CDU: show shutdown
```

Outlet ID	Outlet Name & Hostname/IP	Shutdown/ Delay (sec)	Script/ Delay (min)
.A1	DataServer_1 Windows2003	Yes /90	Yes /10
.A2	WebServer_1 <not set>	No /120	No /1
.A3	FileServer_1 <not set>	No /90	No /1
.A4	TowerA_Outlet4 <not set>	No /90	No /1
.A5	TowerA_Outlet5 <not set>	No /90	No /1
.A6	TowerA_Outlet6 <not set>	No /90	No /1
.A7	TowerA_Outlet7 <not set>	No /90	No /1
.A8	TowerA_Outlet8 <not set>	No /90	No /1



## Chapter 5: Appendices

### Appendix A: Resetting to Factory Defaults

You can reset the non-volatile RAM that stores all configurable options. This clears all administrator-editable fields and resets all command line configurable options to their default values, including all user accounts.

You can reset the unit to factory defaults from the command line or the web interface, or by pressing the reset button. You must have administrator-level privileges to issue the command. Using the reset button may be necessary when a forgotten password prevents administrator login. Each of the methods updates the current working configuration to the factory defaults.

#### Reset to factory defaults

---

**NOTE:** Resetting the unit resets all TCP/IP and Telnet/Web configurations. Reconfiguring the TCP/IP and Telnet/web settings will be required.

---

#### From the Web interface

On the Restart page in the Tools section of the Web interface, select **Restart and reset to factory defaults** from the drop-down menu and click **Apply**.

#### From the command line

At the Switched CDU: prompt, type **restart factory** and press **Enter**.

#### Using the reset button

Locate the recessed reset button directly beside the Serial & Ethernet ports. You will need a non-conductive, non-metallic tool that fits inside the recess.

---

**NOTE:** This method will not work if you disable the **Reset** button.

---

Insert the tool in the recess, then depress and hold the reset button for at least ten seconds.

---

**NOTE:** If you press and hold the **Reset** button for more than 15 seconds, the reset will terminate.

---

#### Reset to factory defaults, except network settings

#### From the Web interface

On the Restart page in the Tools section of the Web interface, select **Restart and reset to factory defaults, except network** from the drop-down menu and click **Apply**.

#### From the command line

---

**NOTE:** At the Switched CDU: prompt, type **restart factory keepnet** and press **Enter**.

---

## Appendix B: Uploading Firmware

You can upload new versions of firmware using File Transfer Protocol (FTP). This allows access to new firmware releases for firmware improvements and new features additions.

---

**NOTE:** To begin an FTP upload session, you must first configure the FTP Host address, username/password, filename, and filepath. For information on configuring the FTP settings required for firmware upload see Chapter 3: Operations.

---

You can initiate an FTP upload session by issuing a command or from the Web interface. Upon initiating an FTP upload session, the unit will restart and upload the firmware file specified with the FTP Filename command from the previously configured FTP Host. You must have administrator-level privileges to initiate an upload.

### **Initiate an FTP upload session from the Web interface**

On the Restart page in the Tools section of the Web interface, select **Restart and upload firmware via FTP** from the drop-down menu and click **Apply**.

### **Initiate an FTP upload session from the command line**

To initiate an FTP firmware upload session:

At the Switched CDU: prompt, type **restart ftpload** and press **Enter**.

## Appendix C: Technical Specifications

### Branch Circuit Protection

Server Technology PDUs are equipped with one of several types of Branch Circuit Protection, including internal fuses, retractable fuse holders, and circuit breakers, as illustrated below.

These fuses and circuit breakers meet the strict safety requirements of UL 60950-1 and EN 60950-1 for Branch Circuit Protection.

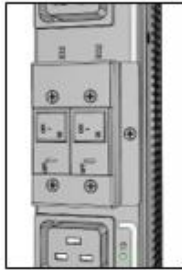

Circuit Breaker



Compact Fuse Holder

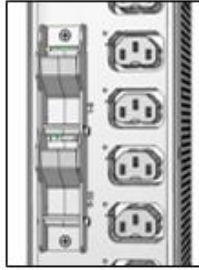

Fuse Retractor



Fuse Access Window

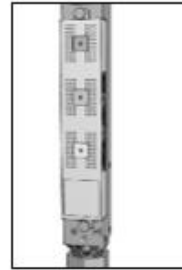

Fuse Access Cover

### Circuit Breaker

If a circuit breaker is tripped, it can be reset by pressing or switching it back ON once the cause of the overload or short circuit has been identified, removed, or resolved. Intelligent PDUs with branch circuit sensing will display a flashing *FE* on the input current LED(s) to indicate *Fuse Error*.

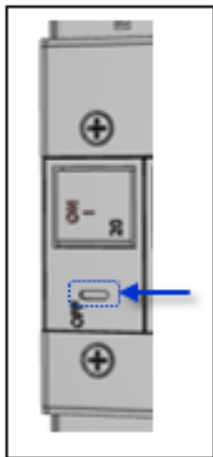

Alternatively, the circuit breaker can be turned OFF manually by inserting a slotted or flat-blade tool into the OFF switch as shown in the illustration on the left.

It is not necessary to disconnect the AC power source to perform this operation.

**NOTE:** This circuit breaker contains no user-serviceable parts. Do not open or disassemble this part.

## Compact Fuse Holder

The Compact Fuse Holder is a UL 98 listed Fused Disconnect Switch that allows the user to turn OFF the branch circuit and safely service the fuse without having to disconnect the PDU AC power source prior to performing this operation.

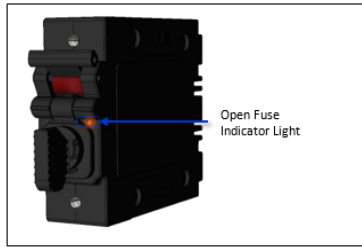

To help identify which fuse is open, blown, or missing, the Open Fuse Indicator Light glows **orange** when the PDU is powered and the Switch Handle is in the ON position.

Additionally, intelligent PDUs with branch circuit sensing will display a flashing *FE* on the input current LEDs to indicate *Fuse Error*.

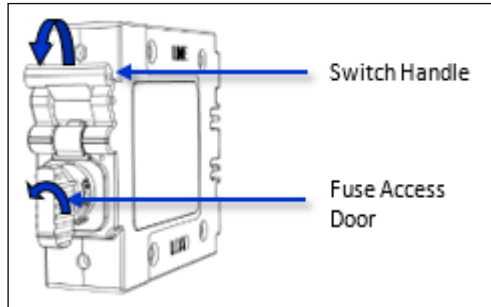

To service the fuse or turn OFF the branch, rotate the Switch Handle toward the Fuse Access Door.

Next, rotate the Fuse Access Door counter clock-wise until it opens.

Only replace the fuse with the same size, type, and ratings as the original fuse.

Reverse these steps after the new fuse(s) is installed.

---

### CAUTION:

- Failure to replace the fuse with the same size, type, and ratings will damage the PDU and the connected and nearby equipment, and will cause electrical shock, fire, explosion, or injury/death.
  - Do not attempt to open the Fuse Access Door without first setting the Switch Handle in the OFF position. Forcibly rotating the Fuse Access Door will damage the fused holder.
-

## Fuse Retractor, Fuse Access Window, and Fuse Access Cover



**The PDU AC power source must be disconnected prior to servicing a unit with the Fuse Retractor, Fuse Access Window, and Fuse Access Cover.**

Intelligent PDUs with branch circuit sensing will display a flashing *FE* on the input current LEDs to indicate *Fault Error*.

For the fuse retractor, rotate the fuse holder exposing the fuse.

For the fuse access window or cover, remove the screws that secure the plastic cover.

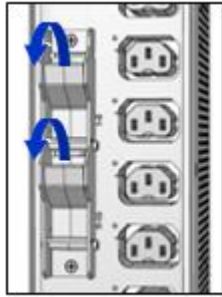

Fuse Retractor



Fuse Access Window



Fuse Access Cover

Once the fuses are exposed, carefully remove and replace with a new one of the same size, type, and ratings as the original. A fuse puller may be needed for fuse access windows and covers.

Reverse these steps after the new fuse(s) is installed.

---

### **CAUTION:**

- Failure to replace the fuse with the same size, type, and ratings will damage the PDU and the connected and nearby equipment, and will cause electrical shock, fire, explosion, or injury/death.
- 

## Time-Delay Fuses – Class G

**NOTE:** Server Technology PDUs ship with Bussman SC-20 fuses.

Ampere Rating	Voltage	Interrupting Rating	Bussman Part No.*	Server Technology Part No.
20 A	600 Vac	100,000 A RMS Sym. AC	SC-20	FUSE-SC20G

\* Cooper Bussman Technical Data Sheet 1024

For technical support or service with time-delay fuses, contact Server Technology as follows:



### **Experience Server Technology's FREE Technical Support**

Server Technology understands that there are often questions when installing and/or using a new product. Free Technical Support is provided from 8 a.m. to 5 p.m. PST, Monday through Friday. After-hours service is provided to ensure your requests are handled quickly no matter what time zone or country you are located in.

Server Technology, Inc.

1040 Sandhill Drive

Tel: 1-800-835-1515

Web: [www.servertech.com](http://www.servertech.com)

Reno, Nevada 89521 USA

Fax: 775-284-2065

Email: [support@servertech.com](mailto:support@servertech.com)

## Data Connections

### RS-232 port

Commanders are equipped standard with an RJ45 DTE RS-232c serial port. This connector may be used for direct local access or from other serial devices such as a terminal server. An RJ45 crossover cable is provided for connection to an RJ45 DCE serial port.

Pin	DTE Signal Name		Input/Output
1	Request to Send	RTS	Output
2	Data Terminal Ready	DTR	Output
3	Transmit Data	TD	Output
4	Signal Ground		
5	Signal Ground		
6	Receive Data	RD	Input
7	Data Set Ready	DSR	Input
8	Clear to Send	CTS	Input

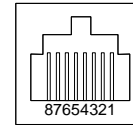

### RJ45 to DB9F serial port adapter

Additionally, an RJ45 to DB9F serial port adapter is provided for use in conjunction with the RJ45 crossover cable to connect to a PC DB9M DCE serial port. The adapter pinouts below reflect use of the adapter with the provided RJ45 crossover cable.

Pin	DCE Signal Name		Input/Output
1			
2	Receive Data	RD	Output
3	Transmit Data	TD	Input
4	Data Terminal Ready	DTR	Input
5	Signal Ground		
6	Data Set Ready	DSR	Output
7	Request to Send	RTS	Input
8	Clear to Send	CTS	Output

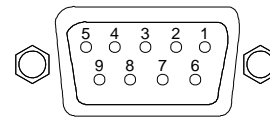

### Modem Port

Commanders are equipped standard with a DB9-male RS-232C DTE Modem serial port. This connector is typically used to connect to an external modem, but may also be used to connect to any RS-232C device. A 9-pin female to 25-pin male cable is included for connecting the Commanders to an external modem.

Pin	DTE Signal Name		Input/Output
1	Data Carrier Detect	DCD	Input
2	Receive Data	RD	Input
3	Transmit Data	TD	Output
4	Data Terminal Ready	DTR	Output
5	Signal Ground		
6	Data Set Ready	DSR	Input
7	Request to Send	RTS	Output
8	Clear to Send	CTS	Input

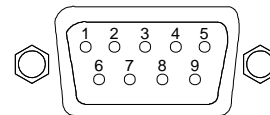

**NOTE:** To connect to a PC serial port, a null-modem adapter and a female-to-female gender changer are required, in addition to the included cable.

## Pass-Thru Port

The Commander is equipped with four RJ12 DTE Pass-Thru ports for connection to serial devices. RJ12 crossover cables are provided for connection along with adapters for connection to standard RS-232C 9 and 25 pin, DTE and DCE serial ports.

Pin	DTE Signal Name		Input/Output
1	Signal Ground		
2	Data Set Ready	DSR	Input
3	Data Receive		Input
4	Data Transmit		Output
5	Data Terminal Ready	DTR	Output
6	Signal Ground		

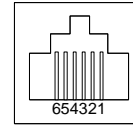

## Regulatory Compliance

### Product Safety

Units have been safety tested and certified to the following standards:

- USA/Canada UL 60950-1:2007 and CAN/CSA 22.2 No. 60950-1-07
- European Union EN60950-1:2006 + A11 + A1 + A12

This product is also designed for Norwegian IT power system with phase-to phase voltage 230V.

### USA Notification

**NOTE:** This equipment has been tested and found to comply with the limits for a Class A digital device, pursuant to part 15 of the FCC Rules. These limits are designed to provide reasonable protection against harmful interference when the equipment is operated in a commercial environment. This equipment generates, uses, and can radiate radio frequency energy and, if not installed and used in accordance with the instruction manual, can cause harmful interference to radio communications. Operation of this equipment in a residential area is likely to cause harmful interference in which case the user will be required to correct the interference at his own expense.

Modifications not expressly approved by the manufacturer could void the user's authority to operated the equipment under FCC rules.

### Canadian Notification

This Class A digital apparatus complies meets all requirements of the Canadian Interference-Causing Equipment Regulations.

Cet appareil numérique de la classe A respecte toutes les exigences du Règlement sur le matériel brouilleur du Canada.

### European Union Notification

Products with the CE Marking comply with both the EMC Directive (89/336/EEC) and the Low Voltage Directive (73/23/EEC) issued by the Commission of the European Community.

Compliance with these directives implies conformity to the following European Norms:

- EN55022 Electromagnetic Interference
- EN55024 Electromagnetic Immunity
- EN60950-1 Product Safety
- EN61000-3 Harmonics and Flicker



Products with the following mark comply with the RoHS Directive (2002/95/EC) issued by the Commission of the European Community.

### Japanese Notification

この装置は、情報処理装置等電波障害自主規制協議会（VCCI）の基準に基づくクラスA情報技術装置です。この装置を家庭環境で使用すると電波妨害を引き起こすことがあります。この場合には使用者が適切な対策を講ずるよう要求されることがあります。

关于符合中国《电子信息产品污染控制管理办法》的声明

产品中有毒有害物质的名称及含量

部件名称 (Parts)	有毒有害物质或元素 (Hazardous Substance)					
	铅 (Pb)	汞 (Hg)	镉 (Cd)	六价铬 (Cr (VI))	多溴联苯 (PBB)	多溴二苯醚 (PBDE)
机箱子组件 (Chassis Subassembly)	O	O	O	O	O	O
印刷板组件 (PCAs)	X	O	O	O	O	O

O 表示该有毒有害物质在该部件所有均质材料中的含量均在SJ/T 11363-2006 标准规定的限量要求以下。  
Indicates that this hazardous substance contained in all homogeneous materials of this part is below the limit requirement in SJ/T 11363-2006.

X 表示该有毒有害物质至少在该部件的某一均质材料中的含量超出SJ/T 11363-2006 标准规定的限量要求。  
Indicates that this hazardous substance contained in at least one of the homogeneous materials of this part is above the limit requirement in SJ/T 11363-2006.



## **Recycling**



Server Technology Inc. encourages the recycling of its products. Disposal facilities, environmental conditions and regulations vary across local, state and country jurisdictions, so Server Technology encourages consultation with qualified professional and applicable regulations and authorities within your region to ensure proper disposal.

## **Waste Electrical and Electronic Equipment (WEEE)**



In the European Union, this label indicates that this product should not be disposed of with household waste. It should be deposited at an appropriate facility to enable recovery and recycling.

## Appendix D: Product Support Information

### Warranty

For the Server Technology warranty information, please see our website at [www.servertech.com](http://www.servertech.com)

### Technical Support



#### **Experience Server Technology's FREE Technical Support**

Server Technology understands that there are often questions when installing and/or using a new product. Free Technical Support is provided from 8 a.m. to 5 p.m. PST, Monday through Friday. After-hours service is provided to ensure your requests are handled quickly no matter what time zone or country you are located in.

Server Technology, Inc.

1040 Sandhill Drive

Tel: 1-800-835-1515

Web: [www.servertech.com](http://www.servertech.com)

Reno, Nevada 89521 USA

Fax: 775-284-2065

Email: [support@servertech.com](mailto:support@servertech.com)

### Return Merchandise Authorization

If you have a unit that is not functioning properly and is in need of technical assistance or repair. Please review Server Technology's Return Merchandise Authorization process at [www.servertech.com](http://www.servertech.com)





## Server Technology®

HEADQUARTERS -  
NORTH AMERICA  
Server Technology, Inc.  
1040 Sandhill Road  
Reno, NV 89521  
United States  
1.775.284.2000 Tel  
1.775.284.2065 Fax  
sales@servertech.com  
www.servertech.com  
www.servertechblog.com

Western Europe, Middle East and  
Africa  
Server Technology  
Fountain Court  
2 Victoria Square  
Victoria Street  
St. Albans  
AL1 3TF  
United Kingdom  
+44 (0) 1727 884676 Tel  
+44 (0) 1727 220815 Fax  
salesint@servertech.com

Central Europe, Eastern Europe and  
Russia  
Niederlassung Deutschland  
Server Technology LLC  
42119 Wuppertal  
Germany  
Tel: + 49 202 693917 x 0  
Fax: + 49 202 693917-10  
salesint@servertech.com

APAC  
Server Technology  
Room 2301, 23/F, Future Plaza  
111-113 How Ming Street,  
Kwun Tong, Hong Kong  
Direct line: +852 3916 2048  
Fax Line: +852 3916 2002  
salesint@servertech.com